

acquabella

CATALOGUE GÉNÉRAL **FR**

acquabella.com

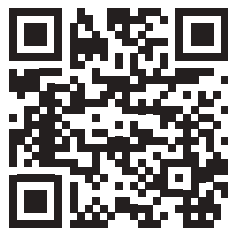

Contactez nos services ADV et SAV France:
Tel : 01 81 22 12 37



Iconographie



Matériau Akron



Découpe sur mesure



Grille inox Base/Arq incluse



Cache bonde Akron Areia inclus



Cache bonde Akron Flow inclus



Top-plein chromé inclus



Facilité d'accès



Matériau Dolotek



Bonde incluse
(Base / Arq / Unic / Areia / Natur / Smart / Focus)



Grille Akron Base/Arq incluse
(3 modèles disponibles)



Grille Akron Natur incluse



Grille Akron Focus incluse



Bonde incluse
(Opat/Quiz / Lech / Dewa / Voss / Chrea / Levi / Vars / Venet / Boreal)



Matériau léger



Le contenu

<i>Société</i>	4-9
<i>Akron</i>	10-11
<i>Textures et couleurs</i>	12-17
<i>Dolotek</i>	18-19
<i>Receveurs de douche</i>	20-141
<i>Baignoires</i>	142-187
<i>Panneaux</i>	188-209
<i>Plans de toilette</i>	210-243
<i>Vasques</i>	244-271
<i>Totems</i>	272-285
<i>Meubles et accessoires</i>	286-323
<i>Information technique</i>	324-344



CLASSE C
UNE-EN 16165:2022 Annexe A
**Beton / Slate / Slate Evo / Arabba / Wave / Zero*



Bonde incluse
(Halo / Tempo / Flow)



Grille Akron Unic incluse
(3 modèles disponibles)



Grille Akron Smart incluse



Grille inox Prisma incluse



Bonde incluse
(Nevis)



Stock: depart usine en 48hrs



Épaisseur maximale et minimale



Bonde incluse
(Prisma)



Cache bonde Akron Halo inclus



Cache bonde Akron Tempo inclus



Top-plein intégré



Pieds réglables inclus

Haute couture pour votre salle de bains

Nous donnons vie à vos idées avec des solutions de salle de bains innovantes et sur mesure qui contribuent à créer des espaces de bien-être. L'innovation et la durabilité nous indiquent le chemin, mais nous ne perdons jamais de vue l'essentiel : les personnes et leur confiance en notre équipe.

Notre essence



Professionalisme

Nous suivons une approche industrielle rigoureuse, précise et fiable grâce à un capital humain qui fait preuve d'un engagement profond dans son travail.



Qualité

Nous avons une attitude responsable à l'égard de la qualité des produits et du service à la clientèle, ce qui nous a permis d'obtenir la certification ISO 9001.



Créativité

L'innovation est l'aliment qui nous nourrit. Grâce à l'écoute active et à la capacité d'innovation de l'équipe, nous créons des produits adaptés aux besoins du public.



Dépassement de soi

Nous sommes en mesure d'améliorer chaque jour nos relations, nos produits et nos services, en visant toujours l'excellence.



Travail d'équipe

Nous travaillons sur la base du respect et de la coopération, en nous appuyant sur des perspectives diverses et en faisant ressortir le meilleur de chaque personne.

Nous concevons des expériences uniques

Nous sommes des créateurs de sensations. Grâce au design, aux textures et aux couleurs, nous élevons l'expérience de la douche à un autre niveau. Chez Acquabella, nous avons notre propre identité qui se reflète dans chacun de nos produits et de nos créations. La combinaison parfaite de la technologie la plus avancée et de l'artisanat offre une attention maximale aux détails, ce qui permet de créer des espaces adaptés à chaque personne ou à chaque projet.



Matériau de qualité certifiée

Des produits fabriqués avec des matériaux très résistants et faciles à entretenir qui garantissent leur durabilité dans le temps.



Adaptabilité

Nous donnons vie à vos idées grâce à la possibilité de découper sur mesure, à la large gamme de formats et à la possibilité de personnaliser nos produits.



Bibliothèque 3D

Nous faisons de vos projets une réalité grâce à la technologie. Découvrez notre bibliothèque 3D et concevez votre propre salle de bains.





Engagement a faveur du développement durable

Chez Acquabella, nous sommes pleinement conscients de notre responsabilité à l'égard de l'environnement et de la société. C'est pourquoi notre entreprise reconnaît les objectifs de développement durable (ODD) adoptés par les Nations unies, comme si c'étaient les siens. De ce point de vue, nous nous engageons à mesurer notre impact environnemental et à mettre en œuvre des actions qui contribuent à une croissance durable.

L'innovation pour transformer l'avenir

Nous voulons créer des expériences uniques en matière de confort, de design et de sécurité. Nous cherchons à avancer main dans la main avec la technologie la plus durable, avec un engagement ferme envers la qualité et en tenant compte des besoins de toutes les personnes qui font partie de notre entreprise et de l'environnement. Cette conviction nous a valu des certifications internationalement reconnues.



9001:2015
Système de gestion de
Qualité



14001:2015
Système de gestion
Environnementale



45001:2018
Système de gestion de sécurité
et santé au travail

Scannez le code QR si vous
souhaitez connaître nos actions RSE



Akron

Akron est un matériau de nouvelle génération composé de polyuréthane et de charges minérales de haute qualité et de granulométrie différente, qui est compacté en masse pour obtenir une finition solide et renforcée. La surface est traitée avec un revêtement en acrylique de polyuréthane qui garantit une intégration physico-chimique totale avec le substrat. La formule avancée d'Akron nous permet de créer des produits avec des textures haute définition, des formes audacieuses et une grande variété de couleurs, ce qui donne des produits au design extraordinaire et aux propriétés techniques élevées. En outre, Akron a été développé de manière efficace et respectueuse de l'environnement. Un avant et un après dans le monde des salles de bains.





Base polyurethane avec charge minérale



Résistant au choc thermique



Antidérapant Classe C
* *Beton / Slate / Slate Evo / Arabba / Wave / Zero*



Isolation acoustique
(DIN 4109 / SIA181 / DIN EN ISO 717-2:2020-01)



Certificat antibactérien
(ISO 22196:2011)



Facile à découper



Classe 1 dans UNE-EN 14527:2016 + A1:2019



Textures haute définition



Résistant à l'hydrolyse. 0% polyester orthophtalique



Découpe sûre-matériau sans silice



Aptitude pour le nettoyage



Matériau 25 % plus léger que les matériaux similaires



Résistance chimique



Évaluation des émissions de COVs des produits d'intérieur (ISO 16000-6:2006) A+ et évaluation de CMR



Résistance aux impacts



Tous les coloris dans toutes les textures

Textures

Nos collections sont conçues pour reproduire des textures haute définition, sophistiquées et élégantes. Nous parvenons à transmettre avec une fidélité étonnante des finitions inspirées de la nature la plus pure. En outre, les textures d'Acquabella sont agréables au toucher, capables de nous transporter dans un univers de sensations pour les 5 sens.

Wave



Quiz

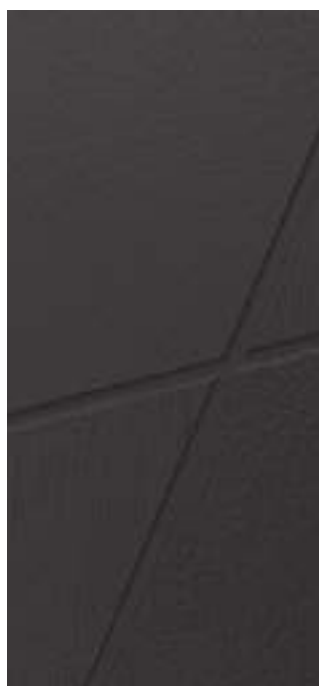

Arabba





Beton



Slate



Zero



Nude



COULEURSSTANDARD



COULEURNATURALLY MADE

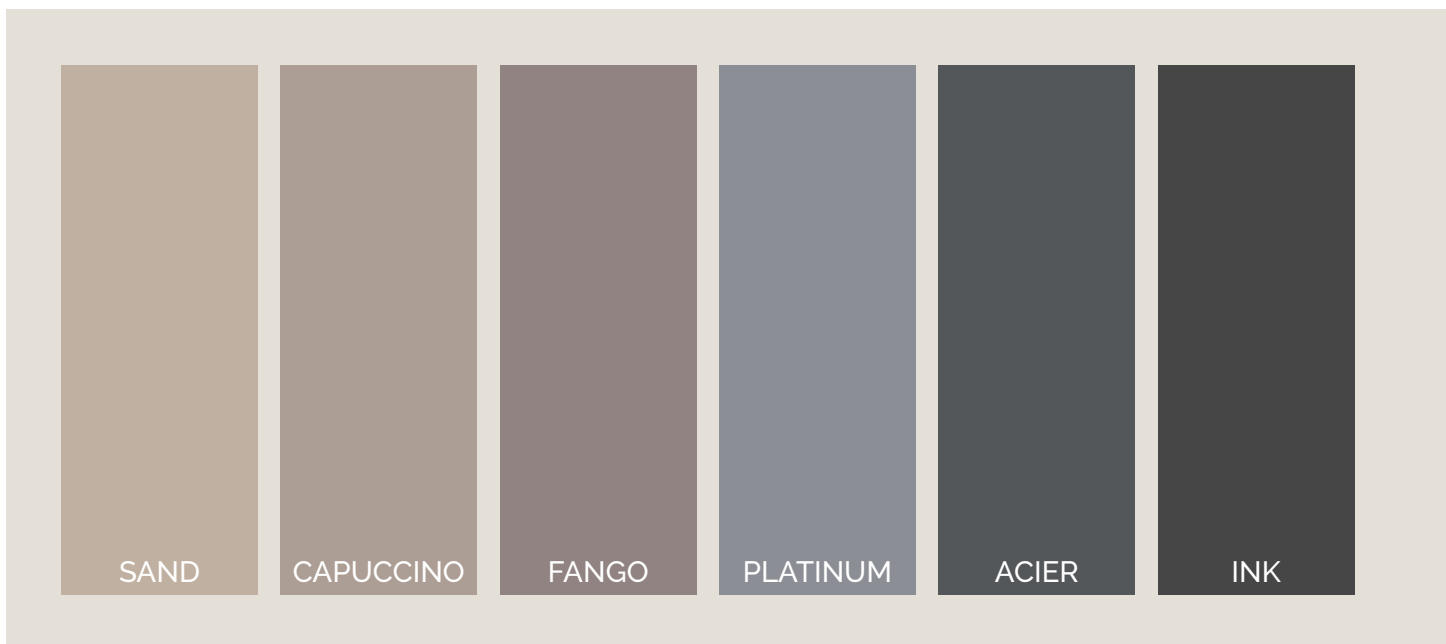

Couleurs

La couleur est notre façon d'exprimer nos émotions. Son utilisation nous permet de donner libre cours à notre créativité et de concevoir des espaces de salle de bains inspirants. Nous vous proposons 4 gammes de couleurs différentes : les couleurs Standard, composées de teintes polyvalentes et intemporelles; les couleurs Naturally Made, inspirées par la force de la nature; les couleurs Season, nouveauté de cette année, une sélection minutieuse de couleurs tendance; et enfin, le nuancier RAL/NCS, composé de plus de 2 000 couleurs. Avec Acquabella, votre imagination sera la limite.

COULEURS RAL/NCS



NOTE: exemples NCS

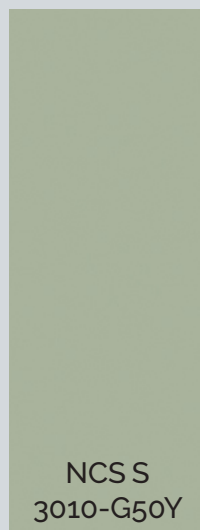

Couleurs Season

Porteurs de design et de tendances, nous avons fait une sélection spéciale de couleurs pour remplir notre salle de bains de couleurs et de fraîcheur. Une ligne chromatique vibrante qui, loin d'être exagérée, transmet un style calme et sophistiqué. Les couleurs Season sont composées d'élégantes nuances, disponibles en version claire et foncée, idéales pour créer des contrastes et des designs uniques. Il est temps d'élargir vos horizons avec les couleurs Season d'Acquabella.





Dolotek

Grâce à la technologie développée, la roche formée il y a des millions d'années est transformée en produits modernes, durables et élégants. Les caractéristiques d'utilisation de Dolotek sont supérieures à celles des matériaux traditionnels, ce qui explique qu'on l'appelle souvent la « céramique du XXI siècle ». Formé de résine et de pierre dolomitique, ce matériau est d'un blanc pur et doux au toucher.

Les propriétés chimiques et physiques de Dolotek permettent la fabrication de produits de haute qualité technique et son moulage en formes complexes dans un design fonctionnel, facilitant ainsi notre quotidien. Le processus technologique qui permet l'élaboration de Dolotek, développé de manière efficace et écologique, est sans précédent dans tout le secteur de la salle de bains.





Composite de résine polyester et pierre dolomite



Revêtement haute performance



Certificat antibactérien
(ISO 22196:2007)



Aptitude pour le nettoyage



Résistant aux UV



Résistant au feu



Résistance chimique



Résistant au choc thermique



Isolation acoustique



Durabilité



Polyvalance



Touche soyeux



Précision



Évaluation des émissions de COVs des produits
d'intérieur (ISO 16000-6:2006) A+ et évaluation de CMR





Receveurs de douche

Nouveau concept de grilles 22-23

Base Slate 24-35

Base Beton 36-43

Base Zero 44-49

Base Nude 50-55

Arq Zero 56-63

Unic Slate 64-73

Halo Slate 74-83

Areia Slate Evo 84-93

Natur Wave 94-103

Smart Quiz 104-111

Tempo Arabba 112-119

Flow Zero 120-127

Focus Beton 128-135

Prisma Slate 136-141

L'evolution de notre essence

Dans notre quête de nous réinventer chaque jour, les modèles Base et Arq évoluent pour offrir de nouvelles options de personnalisation, le portant à un niveau supérieur d'adaptabilité. Nous proposons une collection innovante de grilles: Mia (disponible en Akron et en Inox), Geo et Lux (uniquement disponibles en Akron).



MIA INOX





MIA

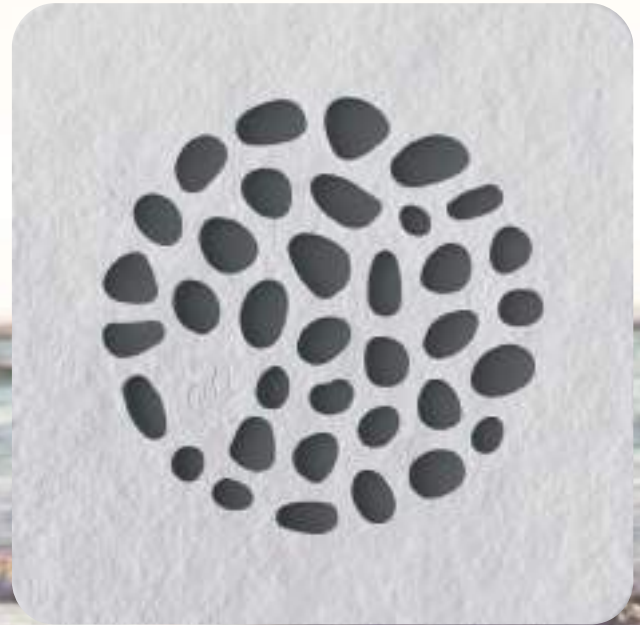

GEO



LUX



Base Slate

Indispensable dans la salle de bains, le modèle Base est habillé de l'élégante texture Slate pour empreindre l'espace de fonctionnalité. Le receveur de douche Base Slate s'adapte parfaitement aux besoins de la salle de bains, grâce à la grande variété de formats qu'il offre et à la possibilité de le découper sur mesure.

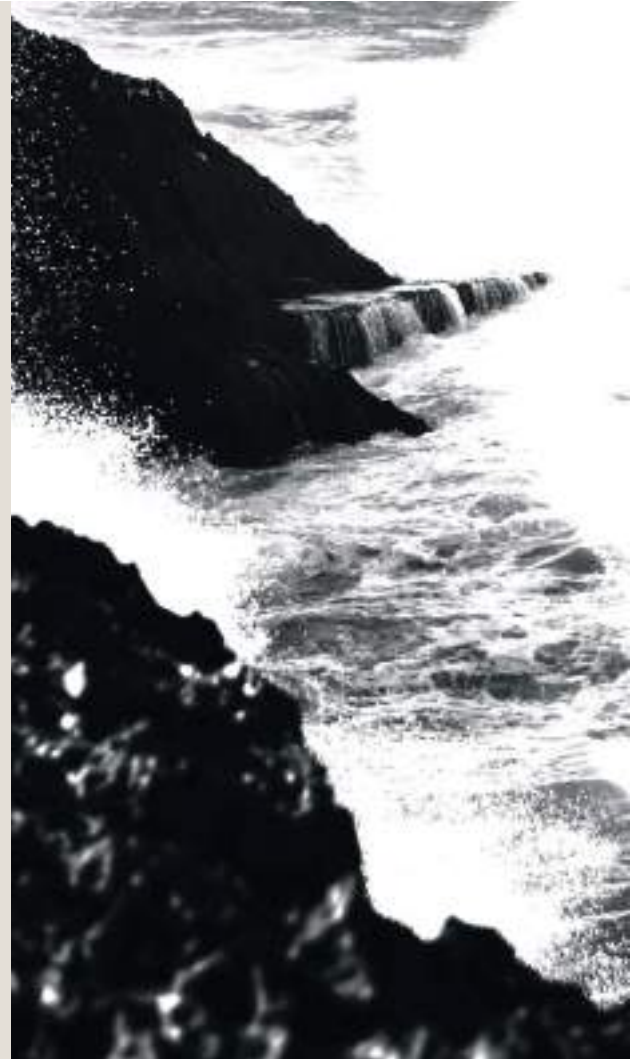

Dimensions standard (cm)

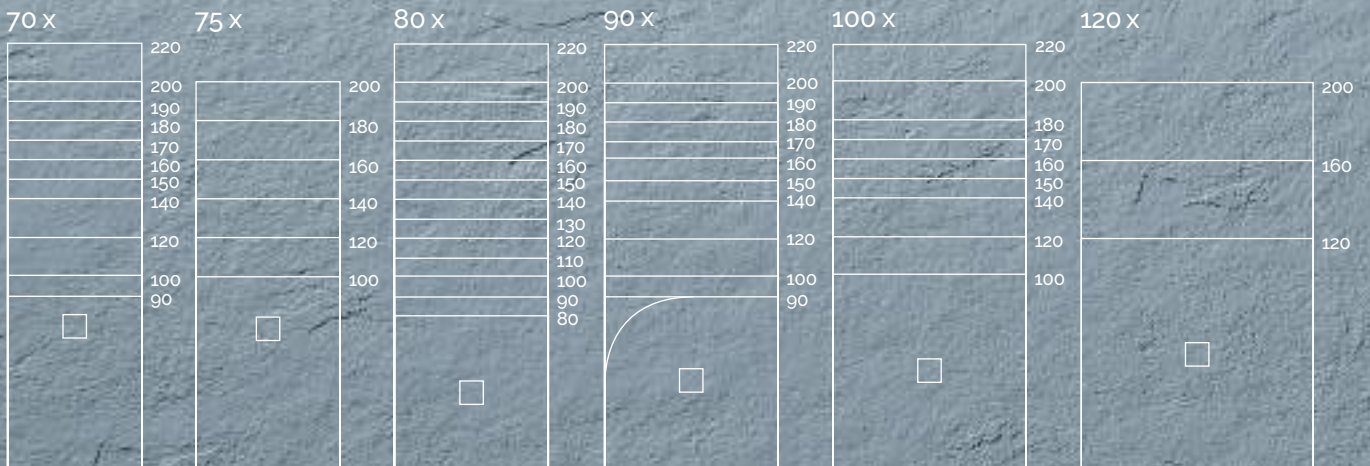

Grilles disponibles

Mia inox



Mia

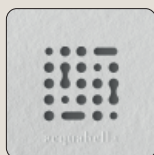

Geo

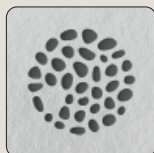

Lux

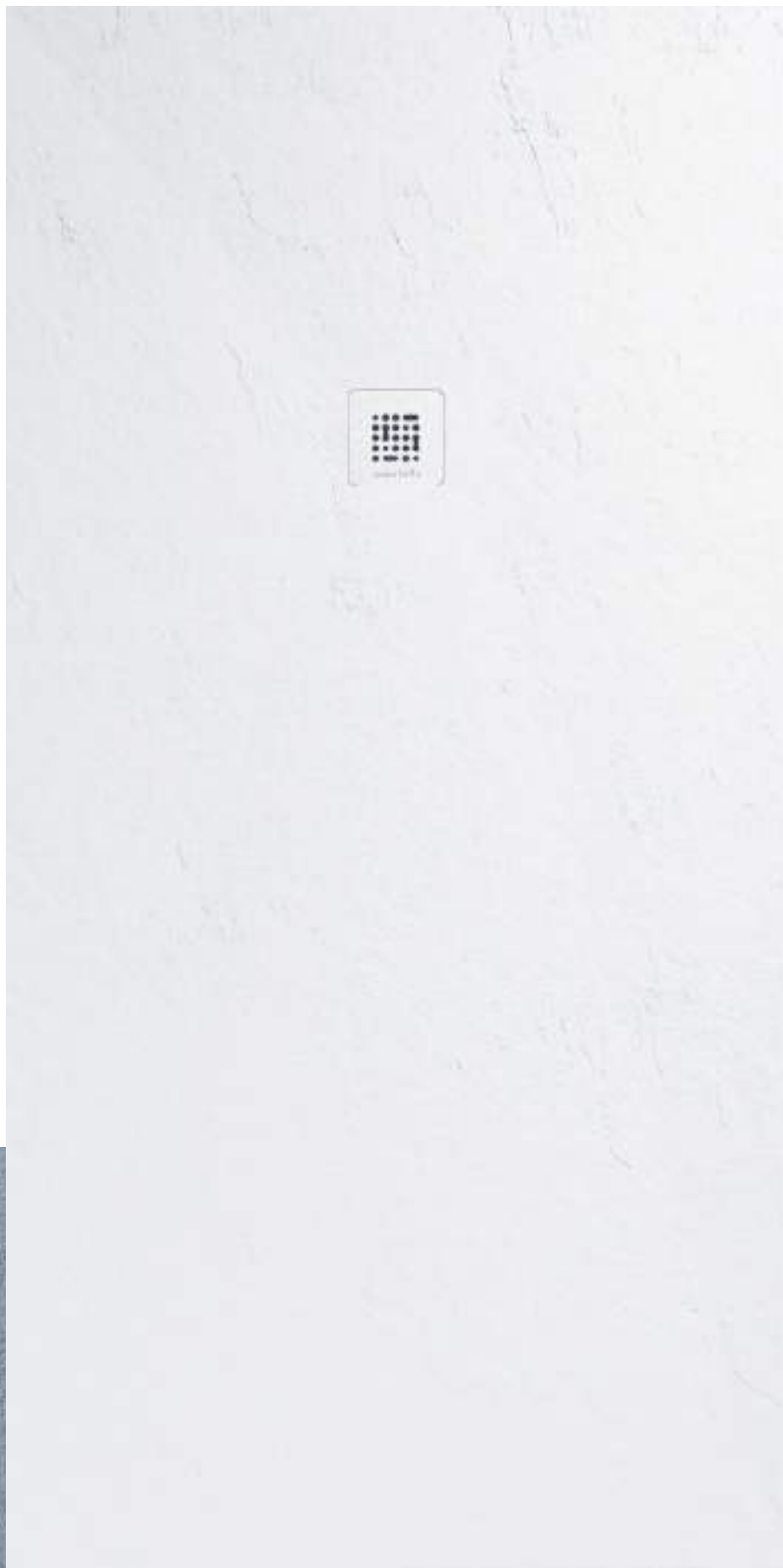









Base Slate



Base Slate blanco 150x90 cm



Couleurs

Standard

blanco nacar beige marfil crema

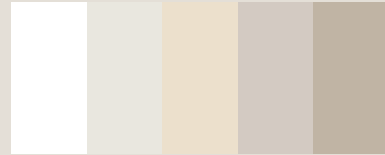

grey cemento moka lava negro



Naturally Made

sand capuccino fango platinum acier ink



Season

burgundy petal ocean sky forest mint

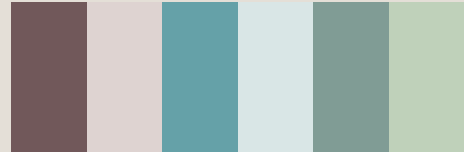

RaI/NCS











BASE SLATECOMPLÉMENTS

Grille

		Texture	Dimensions (cm)	Standard	Nat. Made	Season	Ra/NCS
	Grille Mia inox	-	12 x 12	✓	✓	✓	✓
	Grille Mia Akron	Slate	12 x 12	✓	✓	✓	✓
	Grille Geo Akron	Slate	12 x 12	✓	✓	✓	✓
	Grille Lux Akron	Slate	12 x 12	✓	✓	✓	✓

NOTE: n'est inclus qu'un seul modèle de grille par receveur de douche, à choisir entre: Mia, Geo ou Lux.

Bondes (mm)

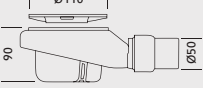
	Bonde standard		✓
	Bonde de sortie verticale		✓
	Bonde extraplate		🛒
	Bonde de haut débit		🛒

NOTE: n'est inclus qu'un seul modèle de bonde par receveur de douche.

Rebord

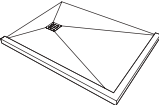
		Texture	Dimensions (cm)	
	Rebord	Slate	4,1 x 5	🛒

Zone de séchage

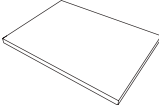



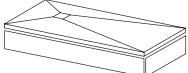

		Texture	Dimensions (cm)	
	Zone de séchage	Slate	100 x 100 x 2,3	🛒

Habillage

		Texture	Dimensions (cm)	
	Habillage	Slate	60 - 220 x 9 x 1,6	🛒



Matériel d'installation

	Kit d'imperméabilisation de base	Kerdi-TS Schlüter Systems	
	Colle fixation	Ultrabond MS Rapid	
	Silicone pour joints	Mapesil AC	

BASE SLATE INFORMATION TECHNIQUE

Découpe sur mesure

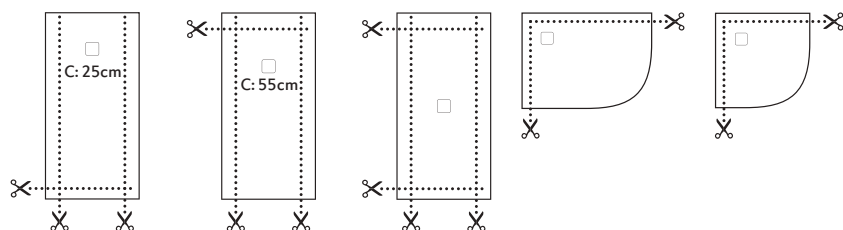

Dimensions

A (cm)	B (cm)	C (cm)	Square			Square with rounded corner		
			A (cm)	B (cm)	C (cm)	A (cm)	B (cm)	C (cm)
90	70/80	25	80	80	40	90	90	26
100	70/75/80/90	25	90	90	45	90 Dx	120	27
110	80	25	100	100	50	90 Sx	120	27
120	70/75/80/90/100	25	120	120	60			
130	80	25						
140	70/75/80/90/100	55						
150	70/80/90/100	55						
160	70/75/80/90/100/120	55						
170	70/80/90/100	55						
180	70/75/80/90/100	55						
180	80/90/100	90						
190	70/80/90	55						
200	70/75/80/90/100/120	55						
200	80/90/100	100						
220	70/80/90/100	110						

Essais

Texture	Essai	Résultat	Fiche technique du produit	Manuel d'installation
SLATE	UNE EN 16165:2022 Annexe A	CLASSE C		
	Normative française XP P 05-010	PN 24		



Base Beton

Le receveur de douche sur mesure Base Beton est capable de donner une touche de fraîcheur à n'importe quelle salle de bains grâce à la texture en aspect ciment. Sa simplicité en fait un grand allié pour les combinaisons avec d'autres éléments, tandis que sa texture informelle en fera le point de mire de la salle de bains.



Dimensions standard (cm)

70 x

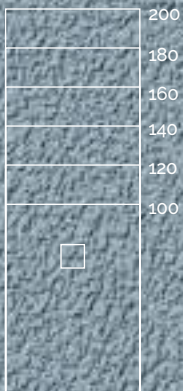

80 x

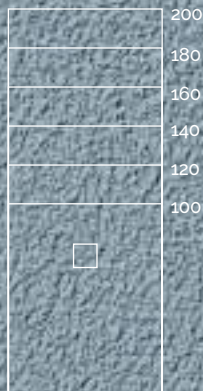

90 x

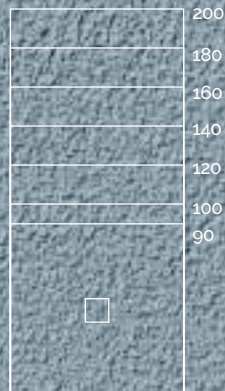

100 x

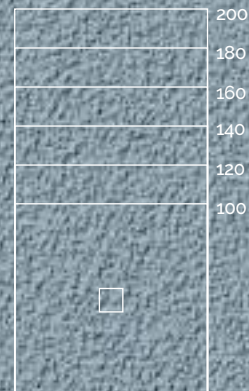

Grilles disponibles

Mia inox



Mia

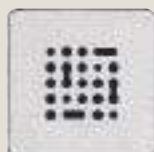

Geo



Lux







Base Beton



Base Mia Beton NCS S 3040-Y60R 200x100 cm



Couleurs

Standard

blanco nacar beige marfil crema

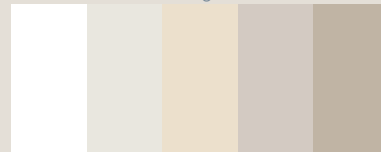

grey cemento moka lava negro



Naturally Made

sand capuccino fango platinum acier ink

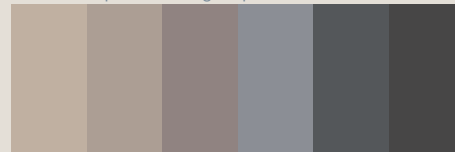

Season

burgundy petal ocean sky forest mint

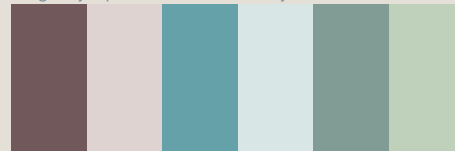





Ra/NCS



BASE BETON COMPLÉMENTS

Grille

		Texture	Dimensions (cm)	Standard	Nat. Made	Season	RaL/NCS
	Grille Mia inox	-	12 x 12	✓	✓	✓	✓
	Grille Mia Akron	Beton	12 x 12	✓	✓	✓	✓
	Grille Geo Akron	Beton	12 x 12	✓	✓	✓	✓
	Grille Lux Akron	Beton	12 x 12	✓	✓	✓	✓

NOTE: n'est inclus qu'un seul modèle de grille par receveur de douche, à choisir entre: Mia, Geo ou Lux.

Bondes (mm)

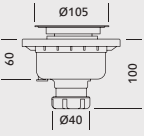
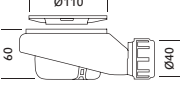
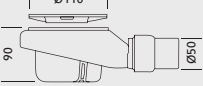
	Bonde standard		✓
	Bonde de sortie verticale		✓
	Bonde extraplate		🛒
	Bonde de haut débit		🛒

NOTE: n'est inclus qu'un seul modèle de bonde par receveur de douche.

Rebord

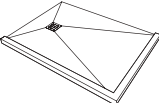
		Texture	Dimensions (cm)	
	Rebord	Beton	4,1 x 5	🛒

Habillage

		Texture	Dimensions (cm)	
	Habillage	Beton	60 - 200 x 9 x 1,6	🛒



Matériel d'installation



Kit d'imperméabilisation de base

Kerdi-TS Schlüter Systems



Colle fixation

Ultradbond MS Rapid



Silicone pour joints

Mapesil AC



BASE BETON INFORMATION TECHNIQUE

Découpe sur mesure

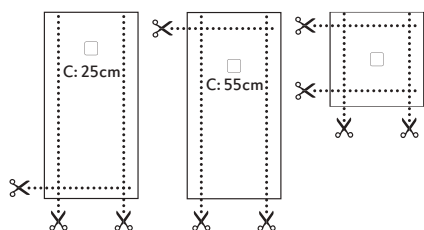

Dimensions

	A (cm)	B (cm)	C (cm)		A (cm)	B (cm)	C (cm)
	100	70/80/90	25		90	90	45
	120	70/80/90/100	25		100	100	50
	140	70/80/90/100	55				
	160	70/80/90/100	55				
	180	70/80/90/100	55				
	200	70/80/90/100	55				

Essais

Texture	Essai	Résultat
BETON	UNE-EN 16165:2022 Annexe A	CLASSE C
	Normative française XP P 05-010	PN 24

Fiche technique
du produitManuel
d'installation



Base Zero

Le receveur de douche sur mesure Base Zero est constitué d'une microtexture pratiquement lisse, ce qui en fait un élément essentiel du design moderne. Son minimalisme permettra d'obtenir un intérieur polyvalent et intemporel, indispensable dans les maisons et les hôtels. Base Zero offrira à toute salle de bain un espace sans égal.



Dimensions standard (cm)

70 x



80 x



90 x

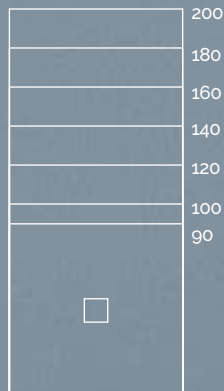

100 x

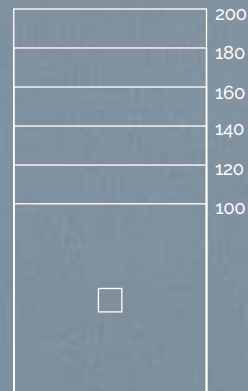

Grilles disponibles

Mia inox



Mia



Geo



Lux



Base Zero



Base Mia Zero negro 200x100 cm



Couleurs

Standard

blanco nacar beige marfil crema

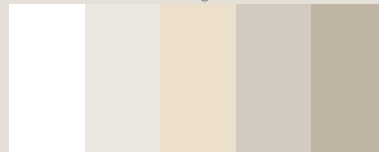

grey cemento moka lava negro



Naturally Made

sand capuccino fango platinum acier ink

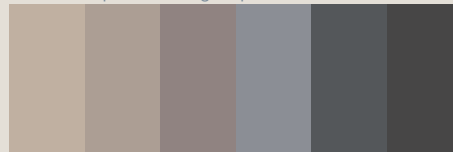

Season

burgundy petal ocean sky forest mint

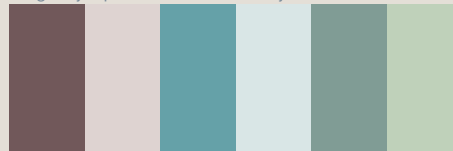





Ra/NCS







BASE ZERO COMPLÉMENTS

Grille

		Texture	Dimensions (cm)	Standard	Nat. Made	Season	RaL/NCS
	Grille Mia inox	-	12 x 12	✓	✓	✓	✓
	Grille Mia Akron	Zero	12 x 12	✓	✓	✓	✓
	Grille Geo Akron	Zero	12 x 12	✓	✓	✓	✓
	Grille Lux Akron	Zero	12 x 12	✓	✓	✓	✓

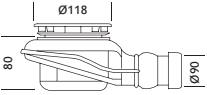
NOTE: n'est inclus qu'un seul modèle de grille par receveur de douche, à choisir entre: Mia, Geo ou Lux.

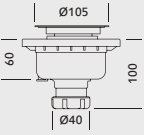
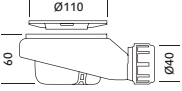
Bondes (mm)

	Bonde standard		✓
	Bonde de sortie verticale		✓
	Bonde extraplate		🛒
	Bonde de haut débit		🛒

NOTE: n'est inclus qu'un seul modèle de bonde par receveur de douche.

Rebord

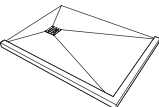
		Texture	Dimensions (cm)	
	Rebord	Zero	4,1 x 5	🛒

Habillage

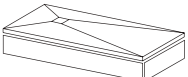
		Texture	Dimensions (cm)	
	Habillage	Zero	60 - 200 x 9 x 1,6	🛒



Matériel d'installation



Kit d'imperméabilisation de base

Kerdi-TS Schlüter Systems



Colle fixation

Ultrabond MS Rapid



Silicone pour joints

Mapesil AC



BASE ZERO INFORMATION TECHNIQUE

Découpe sur mesure

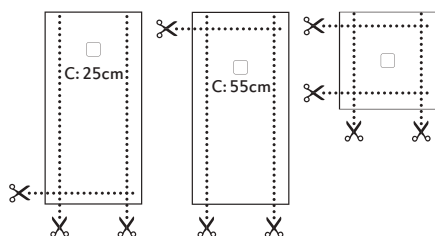

Dimensions

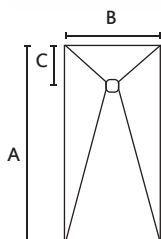

A (cm)	B (cm)	C (cm)
100	70/80/90	25
120	70/80/90/100	25
140	70/80/90/100	55
160	70/80/90/100	55
180	70/80/90/100	55
200	70/80/90/100	55

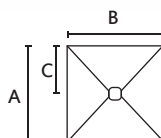

A (cm)	B (cm)	C (cm)
90	90	45
100	100	50

Essais

Texture	Essai	Résultat
ZERO	UNE-EN 16165:2022 Annexe A	CLASSE C
	Normative française XP P 05-010	PN 24

Fiche technique
du produitManuel
d'installation



Base Nude

L'originalité est la marque de fabrique du receveur de douche personnalisé Base Nude. La texture unique Nude haute définition reproduit parfaitement l'aspect de la peau, apportant de la chaleur à l'espace. Un modèle qui, grâce à la simplicité qui le caractérise, met l'accent sur la finition, créant ainsi un receveur de douche élégant et innovant.



Dimensions standard (cm)

80 x

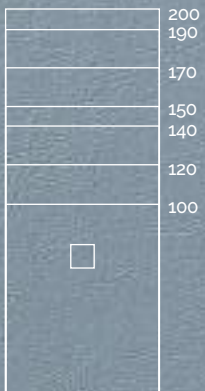

90 x

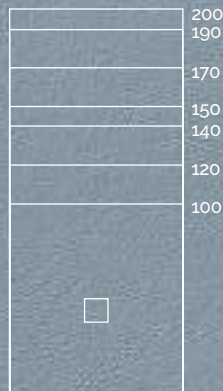

100 x

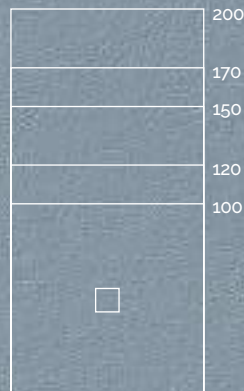

Grilles disponibles

Mia inox



Mia



Geo



Lux



Base Nude



Base Geo Nude crema 170x90 cm



Couleurs

Standard

blanco nacar beige marfil crema

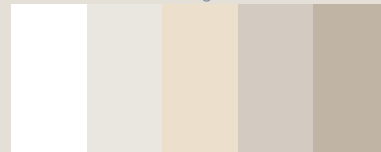

grey cemento moka lava negro



Naturally Made

sand capuccino fango platinum acier ink



Season

burgundy petal ocean sky forest mint

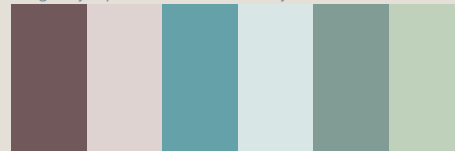





RaI/NCS





BASE NUDE COMPLÉMENTS

Grille

		Texture	Dimensions (cm)	Standard	Nat. Made	Season	Ra/NCS
	Grille Mia inox	-	12 x 12	✓	✓	✓	✓
	Grille Mia Akron	Nude	12 x 12	✓	✓	✓	✓
	Grille Geo Akron	Nude	12 x 12	✓	✓	✓	✓
	Grille Lux Akron	Nude	12 x 12	✓	✓	✓	✓

NOTE: n'est inclus qu'un seul modèle de grille par receveur de douche, à choisir entre: Mia, Geo ou Lux.

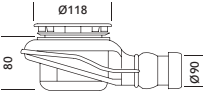
Bondes (mm)

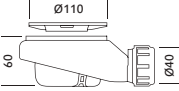
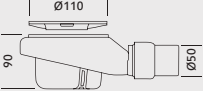
	Bonde standard		✓
	Bonde de sortie verticale		✓
	Bonde extraplate		🛒
	Bonde de haut débit		🛒

NOTE: n'est inclus qu'un seul modèle de bonde par receveur de douche.

Rebord

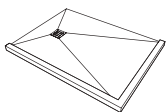
		Texture	Dimensions (cm)	
	Rebord	Nude	4,1 x 5	

Habillage

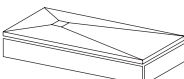
		Texture	Dimensions (cm)	
	Habillage	Nude	60 - 200 x 9 x 1,6	🛒



Matériel d'installation



Kit d'imperméabilisation de base

Kerdi-TS Schlüter Systems



Colle fixation

Ultrabond MS Rapid



Silicone pour joints

Mapesil AC



BASE NUDE INFORMATION TECHNIQUE

Découpe sur mesure

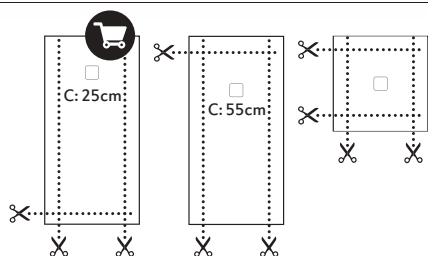

Dimensions

	A (cm)	B (cm)	C (cm)		A (cm)	B (cm)	C (cm)
	100	80/90	25		100	100	50
	120	80/90/100	25				
	140	80/90	55				
	150	80/90/100	55				
	170	80/90/100	55				
	190	80/90	55				
	200	80/90/100	55				

Essais

Texture	Essai	Résultat
NUDE	UNE-EN 16165:2022 Annexe A	CLASSE B
	Normative française XP P 05-010	PN 18

Fiche technique
du produitManuel
d'installation



Arq Zero

Comme s'il s'agissait d'une œuvre d'art, un cadre entoure le receveur de douche personnalisé Arq Zero. Ce modèle s'adapte aux dernières tendances tout en affichant un design intemporel grâce à la micro-texture Zero d'Acquabella. Un choix infaillible lorsqu'il s'agit de rénover le receveur de douche de votre salle de bains.

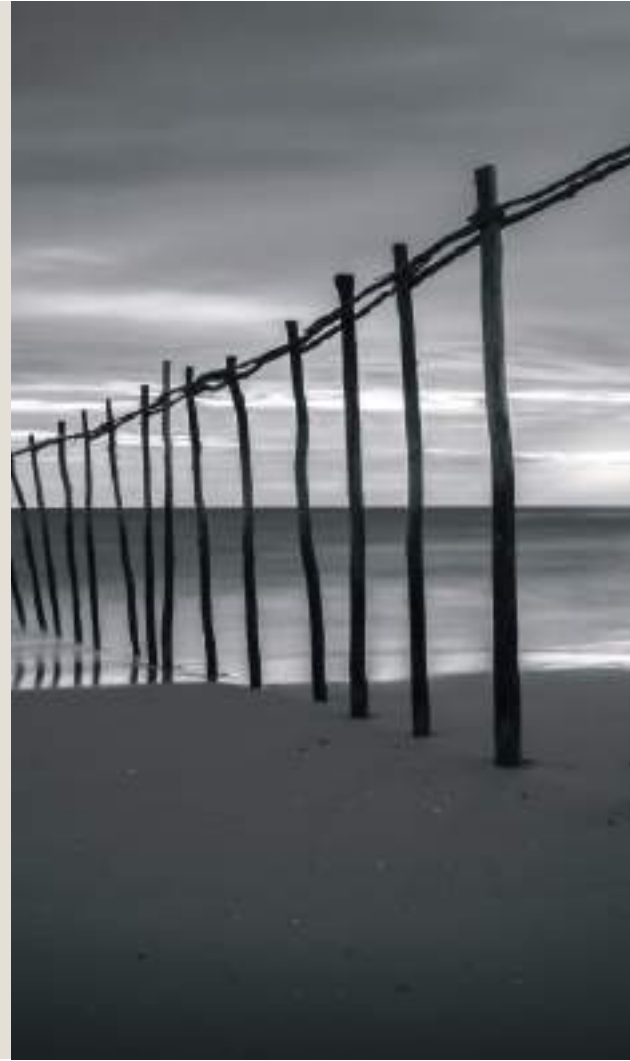

Dimensions standard (cm)

70 x

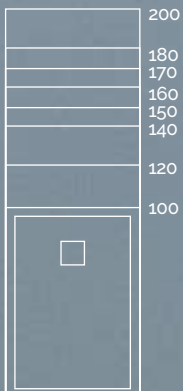

80 x

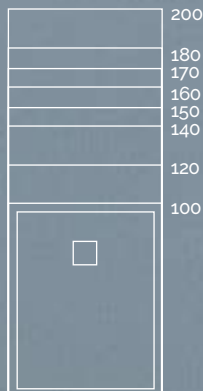

90 x

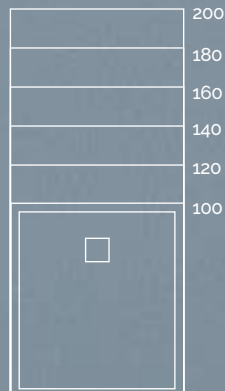

100 x

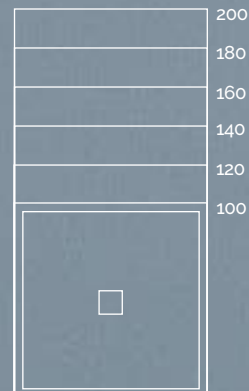

Grilles disponibles

Mia inox



Mia



Geo



Lux







Arq Zero



Arq Zero blanco 200x100 cm



Couleurs

Standard

blanco nacar beige marfil crema

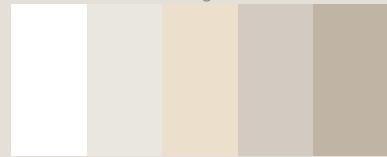

grey cemento moka lava negro



Naturally Made

sand capuccino fango platinum acier ink



Season

burgundy petal ocean sky forest mint

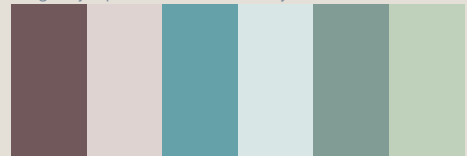





Ra/NCS





ARQ ZERO COMPLÉMENTS

Grille

		Texture	Dimensions (cm)	Standard	Nat. Made	Season	RaL/NCS
	Grille Mia inox	-	12 x 12	✓	✓	✓	✓
	Grille Mia Akron	Zero	12 x 12	✓	✓	✓	✓
	Grille Geo Akron	Zero	12 x 12	✓	✓	✓	✓
	Grille Lux Akron	Zero	12 x 12	✓	✓	✓	✓

NOTE: n'est inclus qu'un seul modèle de grille par receveur de douche, à choisir entre: Mia, Geo ou Lux.

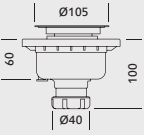
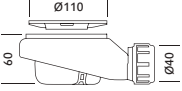
Bondes (mm)



	Bonde standard		✓
	Bonde de sortie verticale		✓
	Bonde extraplate		🛒
	Bonde de haut débit		🛒

NOTE: n'est inclus qu'un seul modèle de bonde par receveur de douche.

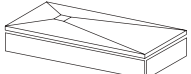
Habillage

		Texture	Dimensions (cm)	
	Habillage	Zero	60 - 200 x 9 x 1,6	🛒

Matériel d'installation

	Kit d'imperméabilisation de base	Kerdi-TS Schlüter Systems	🛒
	Colle fixation	Ultrabond MS Rapid	🛒
	Silicone pour joints	Mapesil AC	🛒

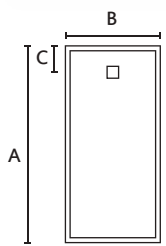
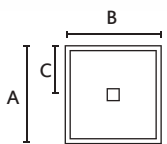

Dimensions

		A (cm)	B (cm)	C (cm)			A (cm)	B (cm)	C (cm)
		100	70/80/90	25		100	100	50	
		120	70/80/90/100	25					
		140	70/80/90/100	25					
		150	70/80	25					
		160	70/80/90/100	25					
		170	70/80	25					
		180	70/80/90/100	25					
		200	70/80/90/100	25					

Essais

Texture	Essai	Résultat
ZERO	UNE-EN 16165:2022 Annexe A	CLASSE C
	Normative française XP P 05-010	PN 24

Fiche technique
du produit



Manuel
d'installation





Unic Slate

Inspiré par le mouvement Néo Art Déco, Acquabella présente le receveur de douche Unic. Ce style décoratif avant-gardiste, caractérisé par des formes géométriques et des matériaux luxueux, est représenté dans l'original Unic Slate. Le receveur de douche Unic présente un élégant arc en pente douce encadré par une grille moderne, le tout dans la texture Slate.



Dimensions standard (cm)

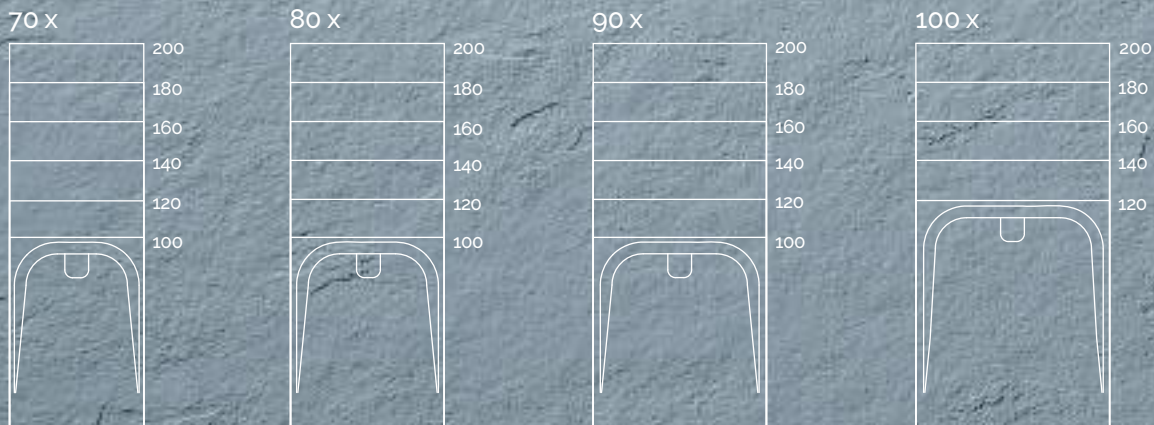

Grilles disponibles

Deco



Dune



Drop

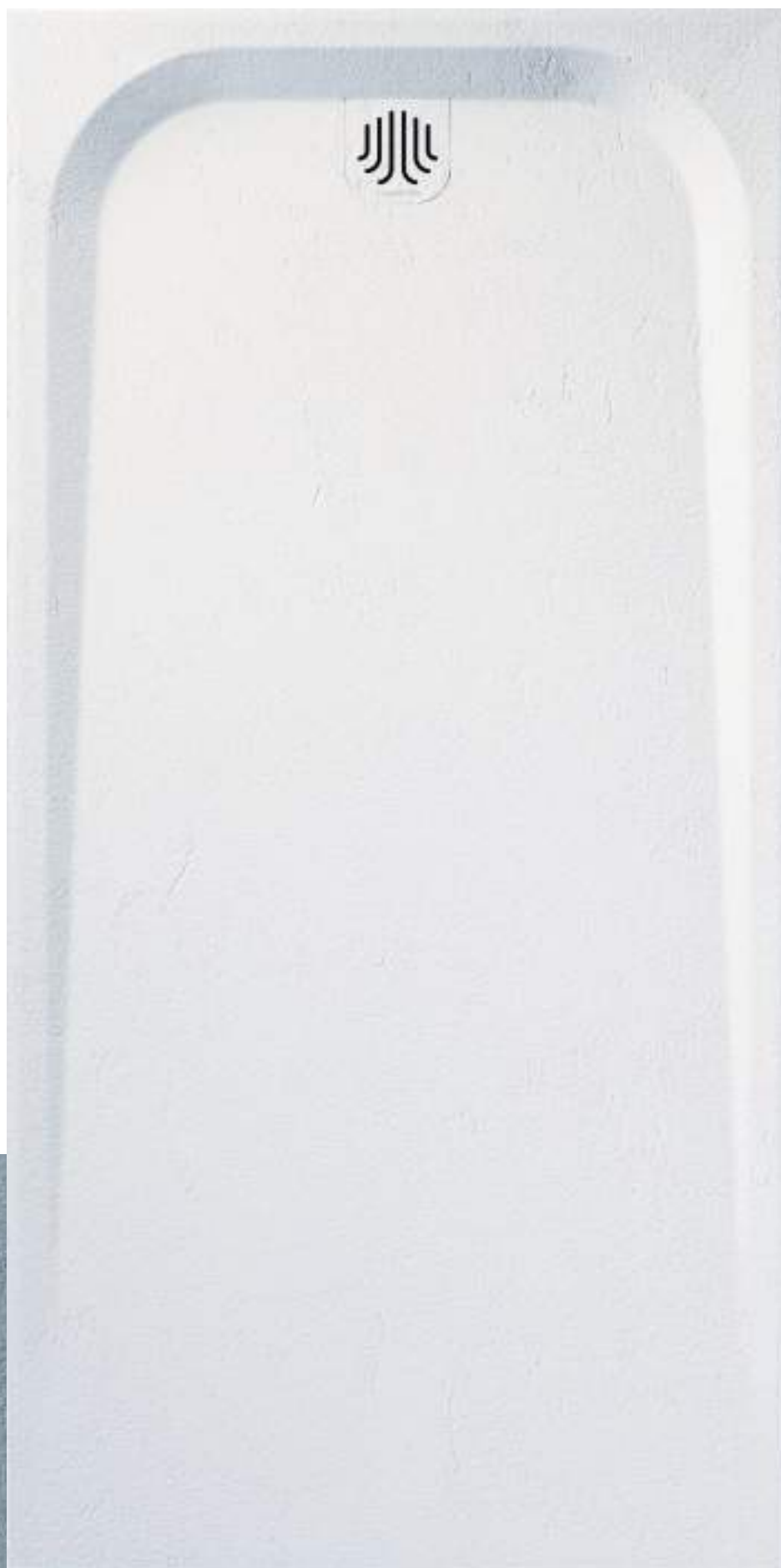

Unic Slate

Le receveur de douche Unic est arrivé pour se démarquer grâce aux 3 designs de grille innovants disponibles : Deco, Dune et Drop. Ce choix permet d'aller plus loin dans la personnalisation du receveur de douche et d'obtenir ainsi l'effet désiré.

Deco





Unic Deco Slate petal 160x90 cm

Dune

Drop

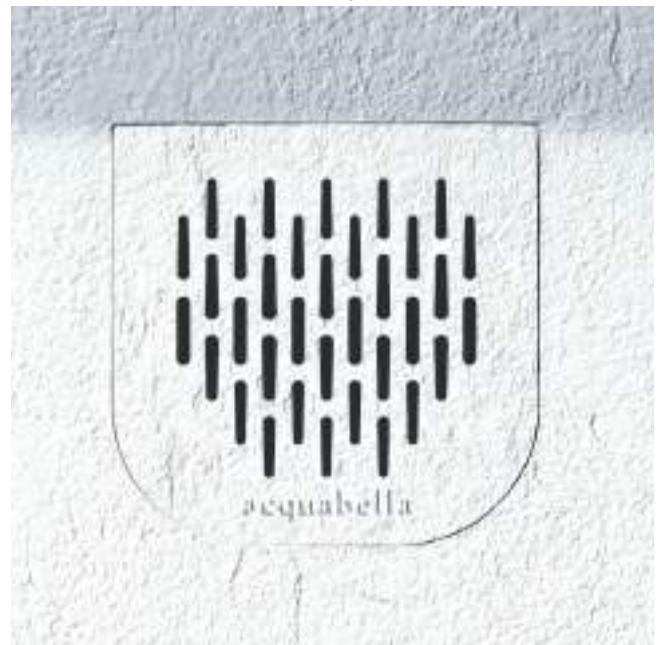





Unic Slate



Unic Drop Slate NCS S 5540-R90B 200x100 cm



Couleurs

Standard



Naturally Made

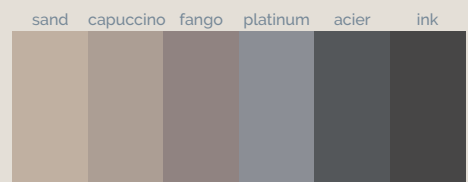

Season

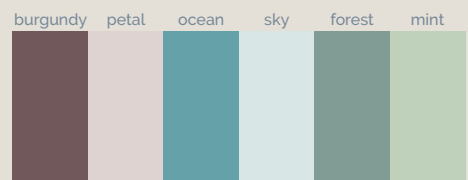















Ra/NCS







UNIC SLATE COMPLÉMENTS

Grille

		Texture	Dimensions (cm)	Standard	Nat. Made	Season	Ra/NCS
	Grille Deco Akron	Slate	12,1 x 12				
	Grille Dune Akron	Slate	12,1 x 12				
	Grille Drop Akron	Slate	12,1 x 12				

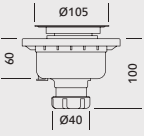
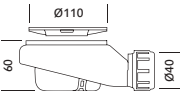

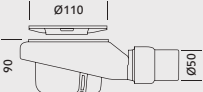
NOTE: n'est inclus qu'un seul modèle de grille par receveur de douche, à choisir entre: Deco, Dune ou Drop.

Bondes (mm)

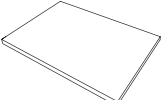

	Bonde standard		
	Bonde de sortie verticale		
	Bonde extraplate		
	Bonde de haut débit		

NOTE: n'est inclus qu'un seul modèle de bonde par receveur de douche.







Zone de séchage

		Texture	Dimensions (cm)	
	Zone de séchage	Slate	100 x 100 x 2,3	

Habillage

		Texture	Dimensions (cm)	
	Habillage	Slate	60 - 200 x 9 x 1,6	

Matériel d'installation

	Kit d'imperméabilisation de base	Kerdi-TS Schlüter Systems	
	Colle fixation	Ultrabond MS Rapid	
	Silicone pour joints	Mapesil AC	



Découpe sur mesure

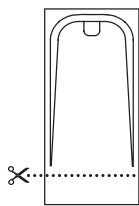

Dimensions

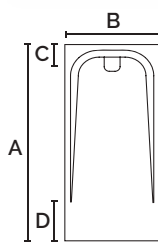
	A (cm)	B (cm)	C (cm)	D (cm)
	100	70/80/90	15,1	20
	120	70/80/90/100	15,1	20
	140	70/80/90/100	15,1	20
	160	70/80/90/100	15,1	20
	180	70/80/90/100	15,1	20
	200	70/80/90/100	15,1	20

Essais

Texture	Essai	Résultat
SLATE	UNE-EN 16165:2022 Annexe A	CLASSE C
	Normative française XPP 05-010	PN 24

Fiche technique
du produit



Manuel
d'installation





Halo Slate

Le minimalisme nous enveloppe avec Halo Slate, un receveur de douche au design encadré. Il se caractérise par un cadre lisse et légèrement descendant, qui crée un contraste subtil avec la définition de la pierre d'ardoise. Halo Slate est couronné d'une grille allongée qui s'intègre dans la forme du cadre, assurant ainsi une bonne évacuation de l'eau.



Dimensions standard (cm)

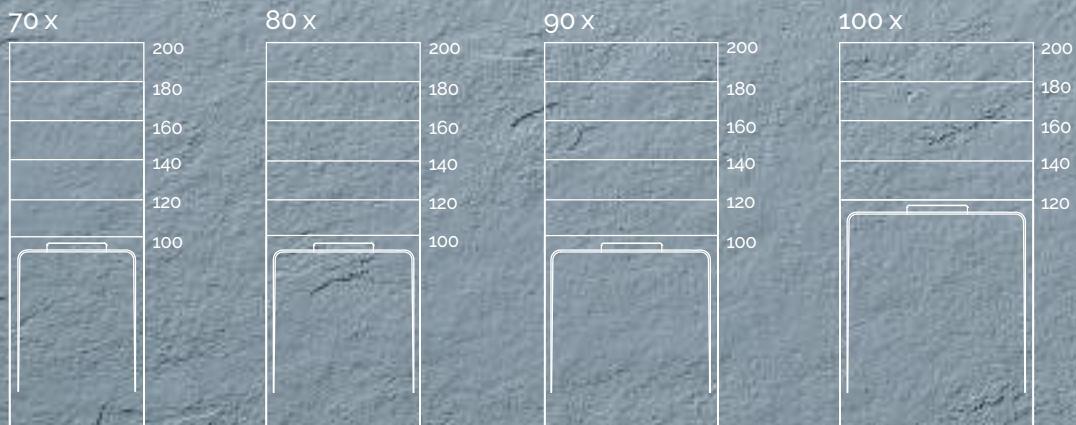

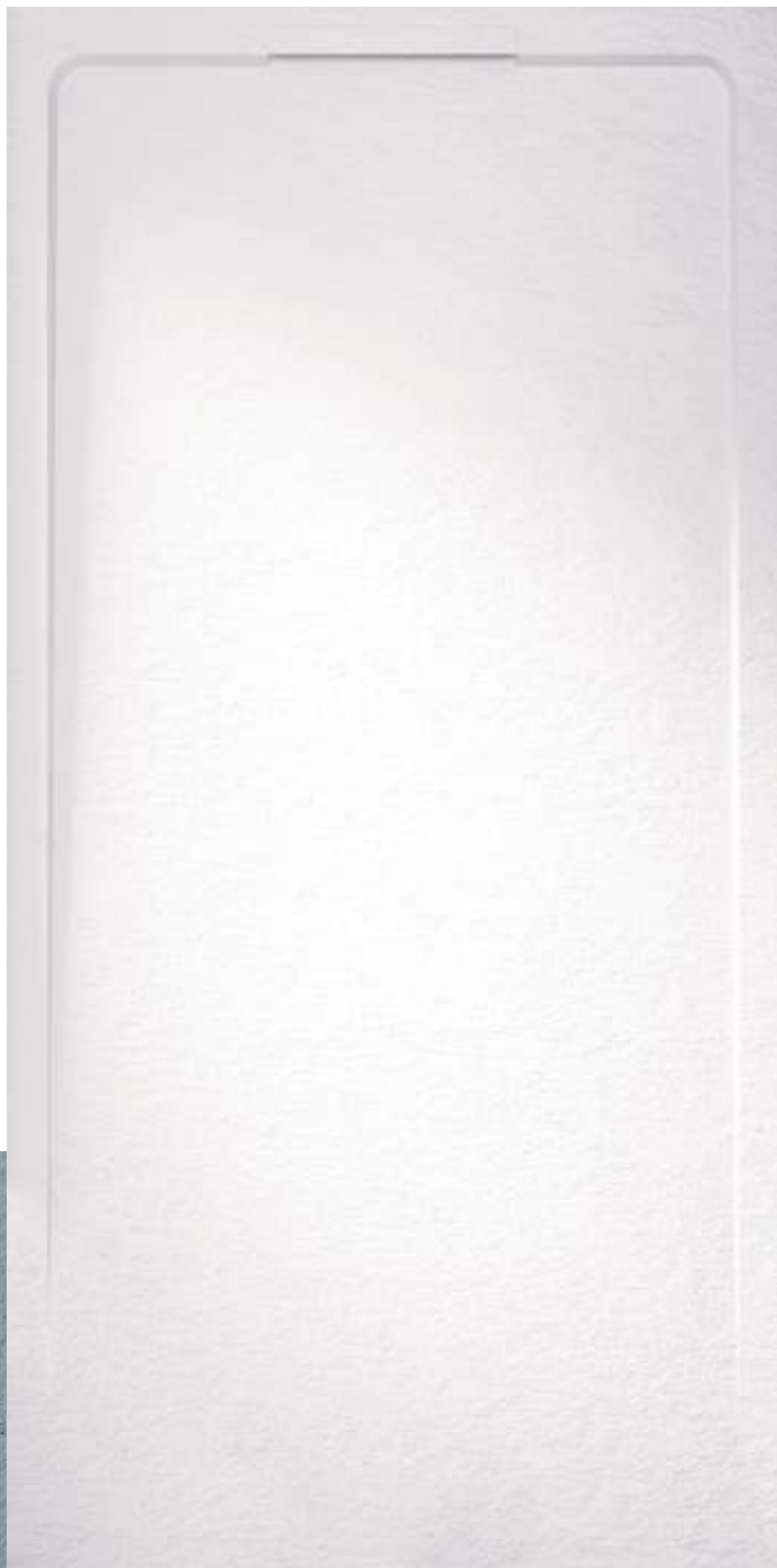





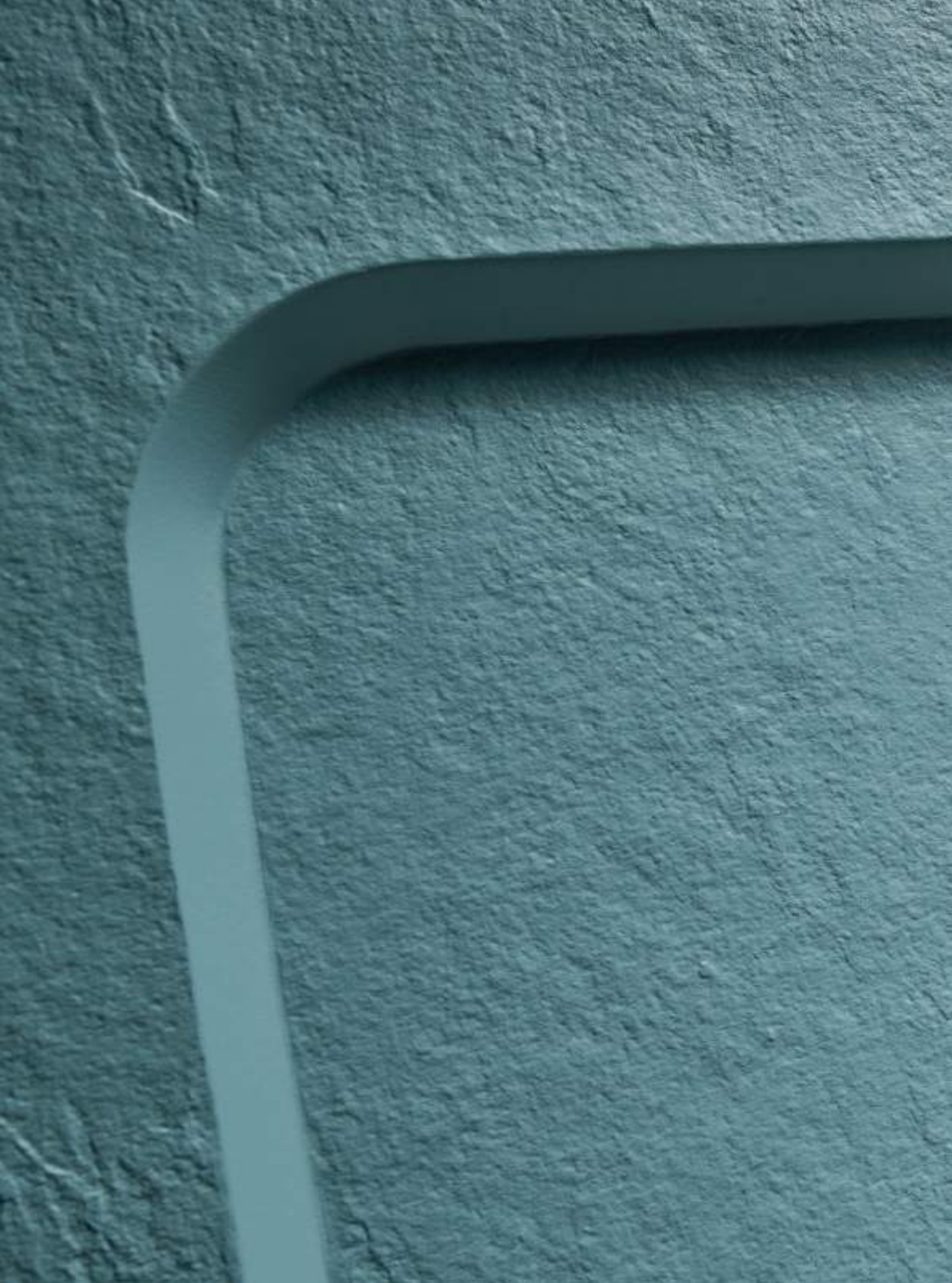



Halo Slate



Halo Slate negro 200x100 cm



Couleurs

Standard

blanco nacar beige marfil crema

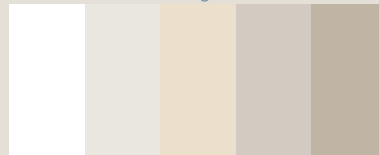

grey cemento moka lava negro

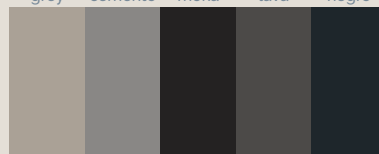

Naturally Made

sand capuccino fango platinum acier ink

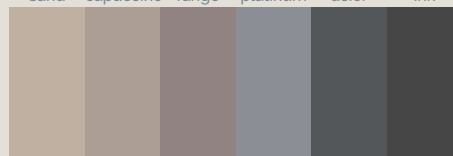

Season

burgundy petal ocean sky forest mint







Ra/NCS



HALO SLATE COMPLÉMENTS



Cache bonde

		Texture	Dimensions (cm)	Standard	Nat. Made	Season	RaL/NCS
	Cache bonde Akron	Slate	31,2 x 3,5				

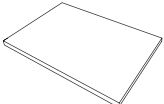

Bonde (mm)

	Bonde line standard						
---	---------------------	--	--	--	--	--	---

Zone de séchage

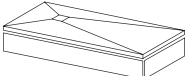

		Texture	Dimensions (cm)	
	Zone de séchage	Slate	100 x 100 x 2,3	

Habillage

		Texture	Dimensions (cm)	
	Habillage	Slate	60 - 200 x 9 x 1,6	

Matériel d'installation

	Kit d'imperméabilisation de base	Kerdi-TS Schlüter Systems	
---	----------------------------------	---------------------------	---

	Colle fixation	Ultrabond MS Rapid	
---	----------------	--------------------	---

	Silicone pour joints	Mapesil AC	
---	----------------------	------------	---

Découpe sur mesure



Dimensions



A (cm)	B (cm)	C (cm)	D (cm)	E (cm)
100	70/80	4,4	20	40
100	90	4,4	20	50
120	70/80	4,4	20	40
120	90/100	4,4	20	50
140	70/80	4,4	20	40
140	90/100	4,4	20	50
160	70/80	4,4	20	40
160	90/100	4,4	20	50
180	70/80	4,4	20	40
180	90/100	4,4	20	50
200	70/80	4,4	20	40
200	90/100	4,4	20	50

Essais

Texture	Essai	Résultat
SLATE	UNE-EN 16165:2022 Annexe A	CLASSE C
	Normative française XPP 05-010	PN 24

Fiche technique
du produit



Manuel
d'installation





Areia Slate Evo

Inspiré de l'érosion causée par la mer sur la roche, Acquabella présente le receveur de douche sur mesure Areia Slate Evo. Son design simple porte l'expérience de la douche à un autre niveau grâce à la texture Slate Evo, une nouvelle version de la texture traditionnelle Slate qui se fond progressivement jusqu'à la grille.



Dimensions standard (cm)

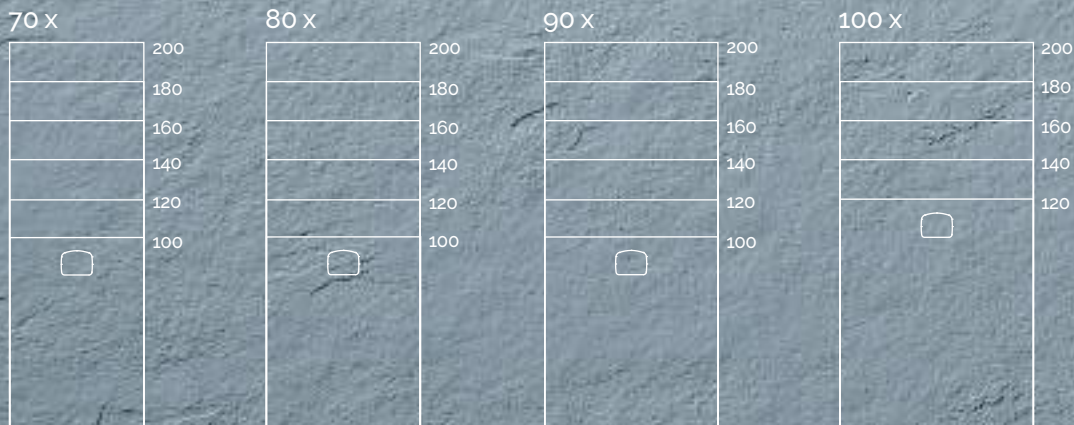

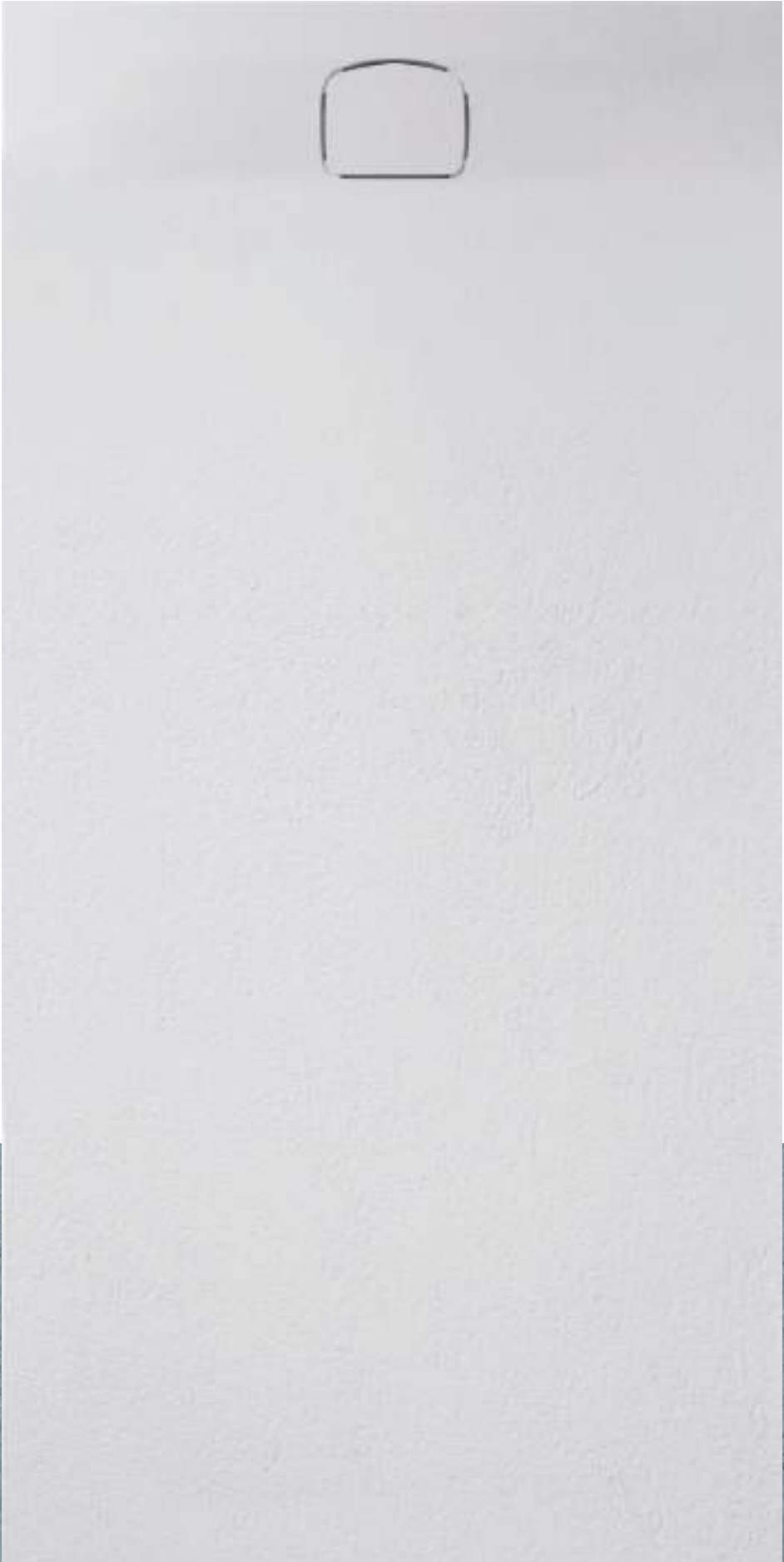

Areia Slate Evo

Le modèle Areia présente une grille rectangulaire aux bords arrondis qui s'adapte parfaitement à la pente douce du receveur de douche.





Areia Slate Evo marfil 180x90 cm

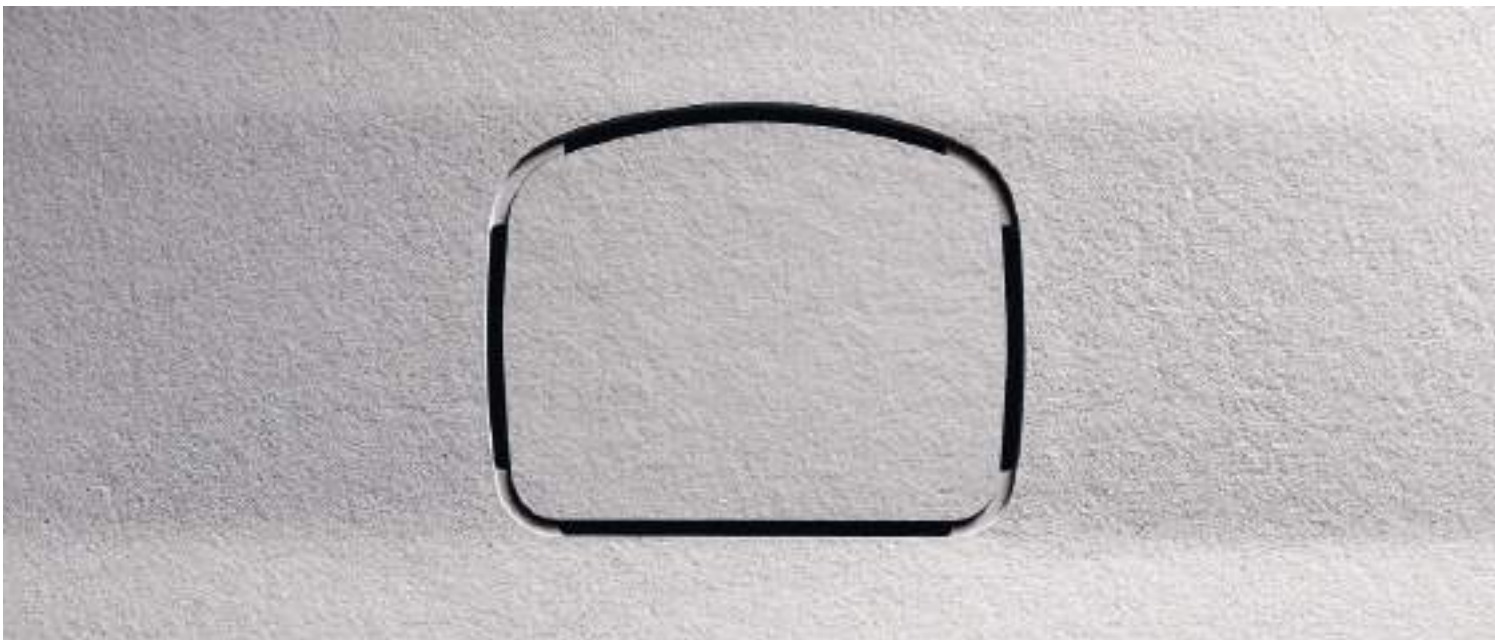

Areia Slate Evo marfil 180x90 cm 87





Areia Slate Evo



Areia Slate Evo NCS S 3030-Y80R 200x100 cm

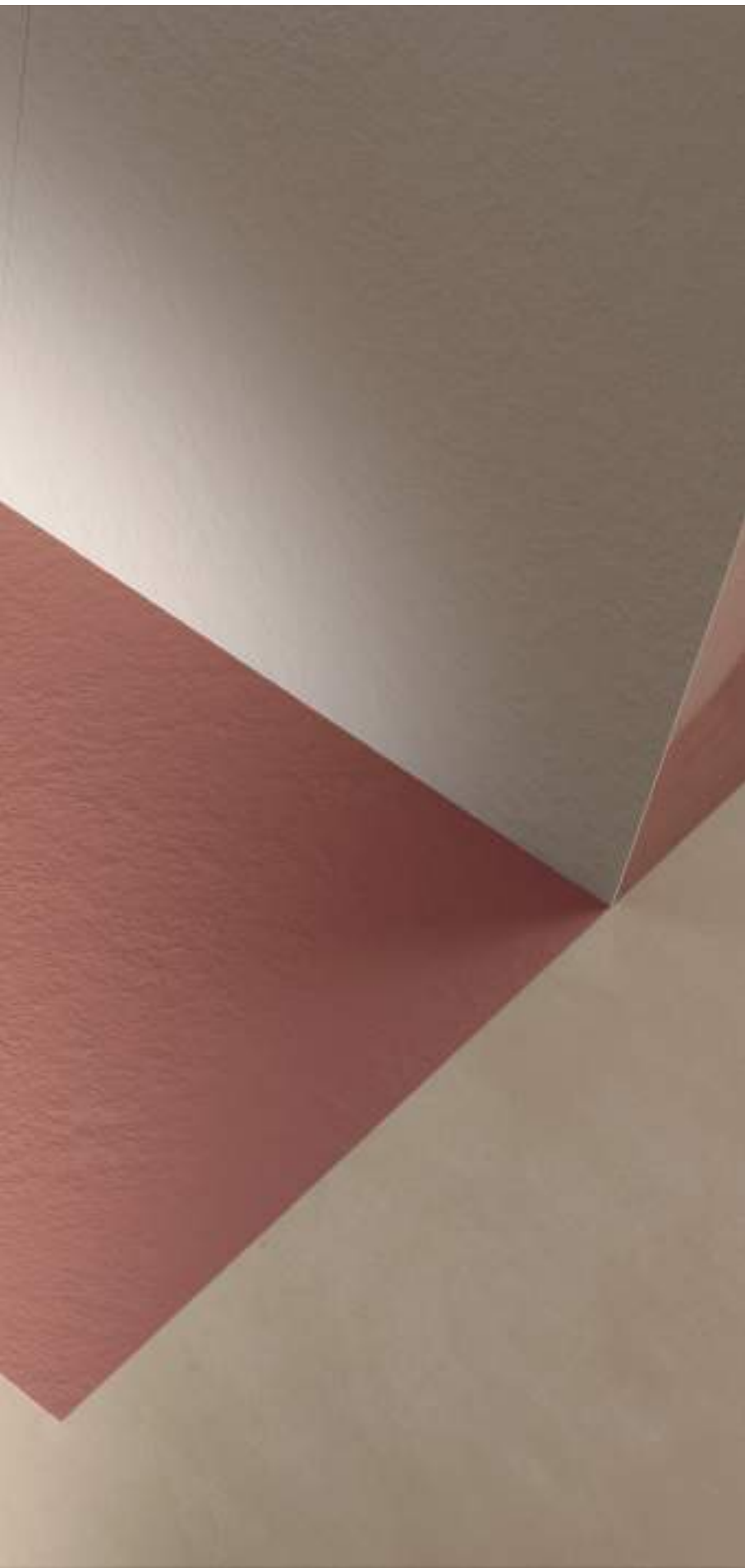

Couleurs

Standard

blanco nacar beige marfil crema

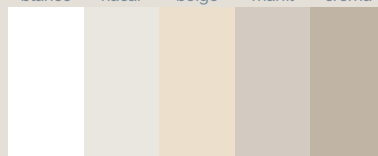

grey cemento moka lava negro

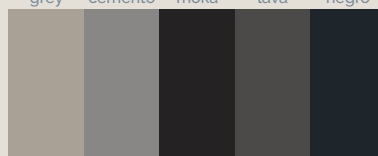

Naturally Made

sand capuccino fango platinum acier ink

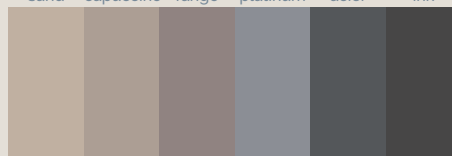

Season

burgundy petal ocean sky forest mint

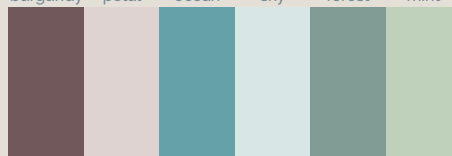





Ra/NCS



AREIA SLATE EVOCOMPLÉMENTS

Cache bonde



		Texture	Dimensions (cm)	Standard	Nat. Made	Season	Ra/NCS
	Cache bonde Akron	Slate Evo	16 x 12,5				

Bondes (mm)





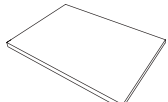

	Bonde standard		
	Bonde de sortie verticale		
	Bonde extraplate		
	Bonde de haut débit		

NOTE: n'est inclus qu'un seul modèle de bonde par receveur de douche.

Zone de séchage

		Texture	Dimensions (cm)	
	Zone de séchage	Slate	100 x 100 x 2,3	

Matériel d'installation

	Kit d'imperméabilisation de base	Kerdi-TS Schlüter Systems	
	Colle fixation	Ultrabond MS Rapid	
	Silicone pour joints	Mapesil AC	



Découpe sur mesure

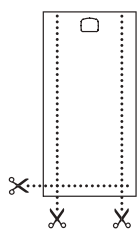

Dimensions

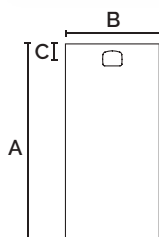
	A (cm)	B (cm)	C (cm)
	100	70/80/90	13,1
	120	70/80/90/100	13,1
	140	70/80/90/100	13,1
	160	70/80/90/100	13,1
	180	70/80/90/100	13,1
	200	70/80/90/100	13,1

Essais

Texture	Essai	Résultat
SLATE EVO	UNE-EN 16165:2022 Annexe A	CLASSE C
	Normative française XPP 05-010	PN 24

Fiche technique
du produit



Manuel
d'installation





Natur Wave

Acquabella présente la texture Wave. Son design s'inspire des motifs dynamiques que l'on peut observer dans la nature. Des anneaux de rugosité différente qui embrassent et dessinent une grille irrégulière, donnant naissance au modèle Natur. Le résultat est un receveur de douche qui affiche design et personnalité sur les quatre côtés.



reddot winner 2023

Dimensions standard (cm)

70 x

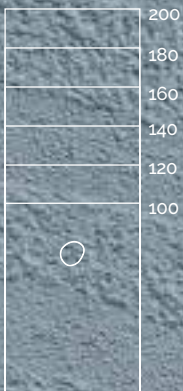

80 x

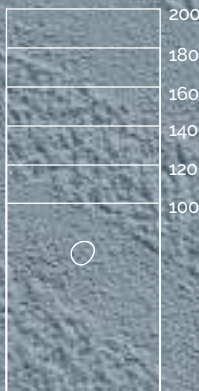

90 x

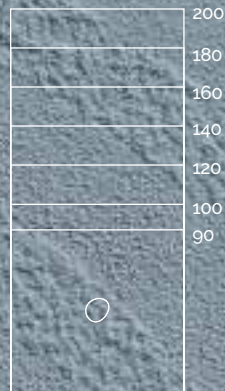

100 x

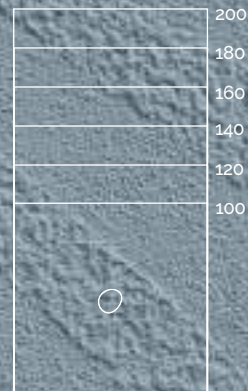











Natur Wave



Natur Wave crema 200x100 cm



Couleurs

Standard

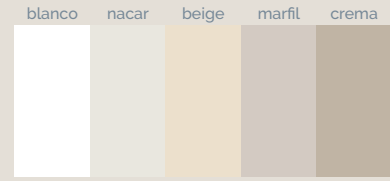

Naturally Made

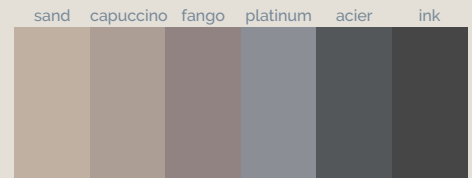

Season

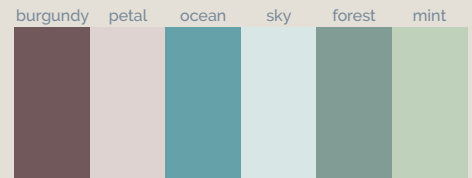





Ra/NCS



NATUR WAVE COMPLÉMENTS

Grille







		Texture	Dimensions (cm)	Standard	Nat. Made	Season	Ra/NCS
	Grille Akron	Wave	14 x 13,9				

Bondes (mm)

	Bonde standard		
	Bonde de sortie verticale		
	Bonde extraplate		
	Bonde de haut débit		

NOTE: n'est inclus qu'un seul modèle de bonde par receveur de douche.

Matériel d'installation

	Kit d'imperméabilisation de base	Kerdi-TS Schlüter Systems	
	Colle fixation	Ultrabond MS Rapid	
	Silicone pour joints	Mapesil AC	



Découpe sur mesure

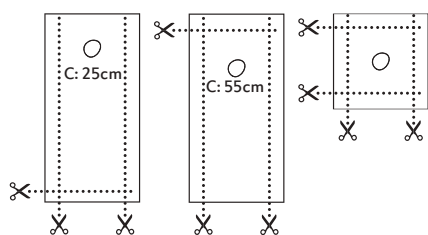

Dimensions

A (cm)	B (cm)	Dimensions			A (cm)	B (cm)	Dimensions		
		A (cm)	B (cm)	C (cm)			A (cm)	B (cm)	C (cm)
		100	70/80/90	25			90	90	45
		120	70/80/90/100	25			100	100	50
		140	70/80/90/100	55					
		160	70/80/90/100	55					
		180	70/80/90/100	55					
		200	70/80/90/100	55					

Essais

Texture	Essai	Résultat
WAVE	UNE-EN 16165:2022 Annexe A	CLASSE C
	Normative française XPP 05-010	PN 24

Fiche technique
du produit



Manuel
d'installation





Smart Quiz

Le receveur de douche Smart Quiz représente l'ADN d'Acquabella : avant-gardiste, créatif et anticonformiste. Un design innovant caractérisé par le puzzle géométrique des textures Beton, Zero et Ethnic. Le receveur de douche sur mesure Smart Quiz est doté d'une grille centrale, entièrement intégrée à la forme du receveur de douche, qui dissimule l'écoulement.



Dimensions standard (cm)

70 x

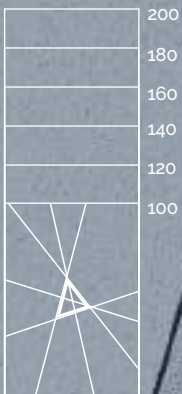

80 x



90 x

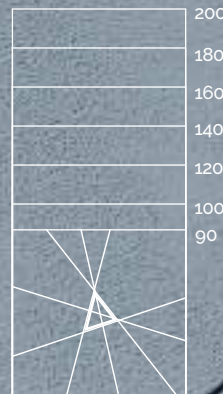

100 x

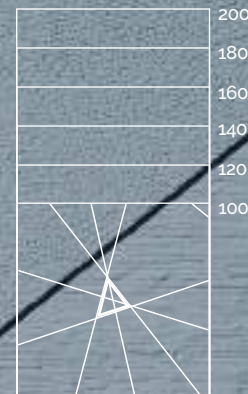

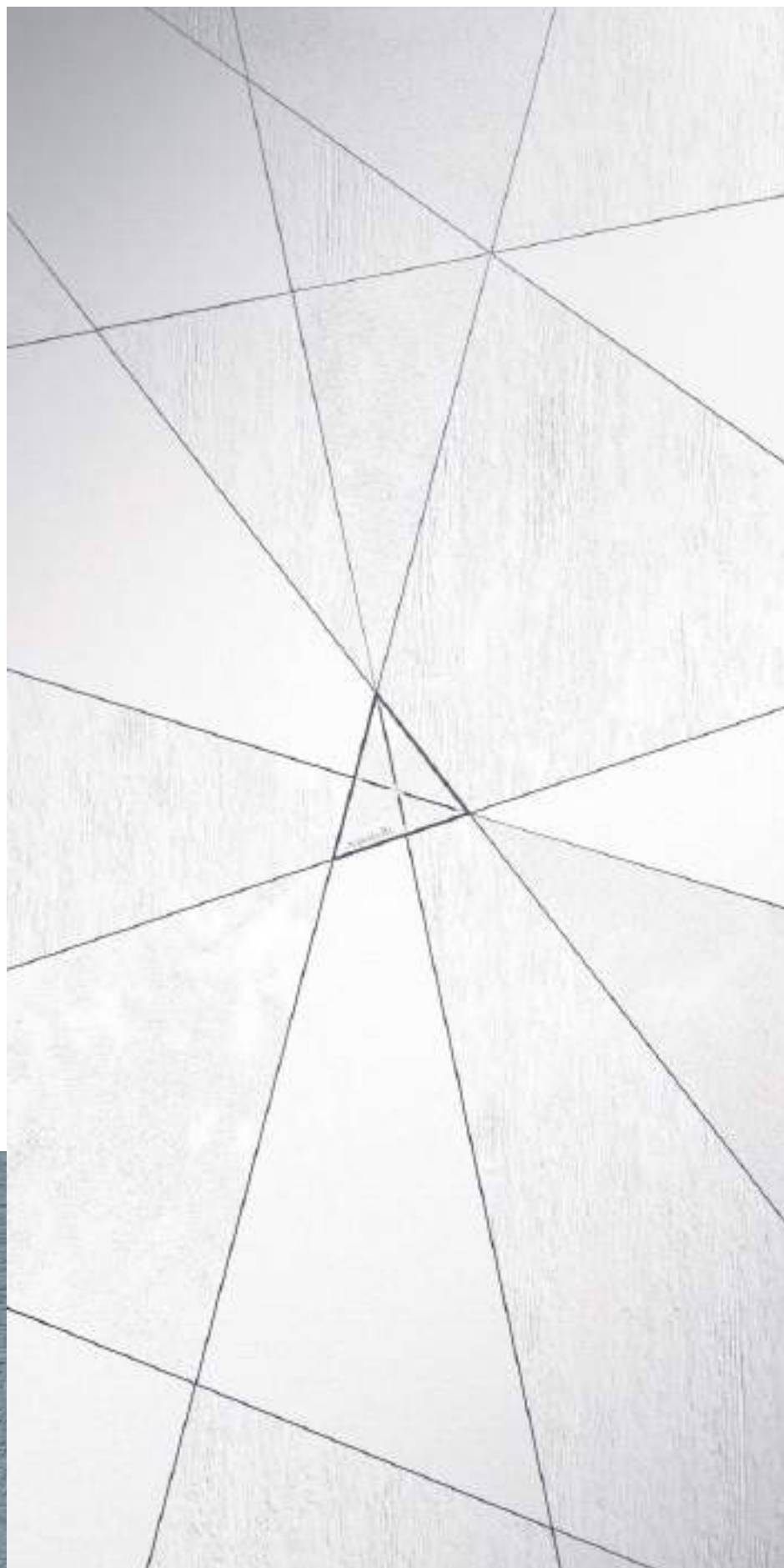





Smart Quiz



Smart Quiz negro 200x100 cm



Couleurs

Standard

blanco nacar beige marfil crema

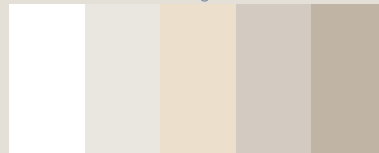

grey cemento moka lava negro

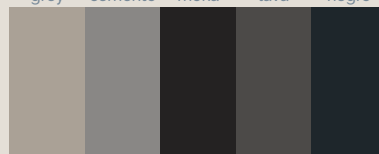

Naturally Made

sand capuccino fango platinum acier ink

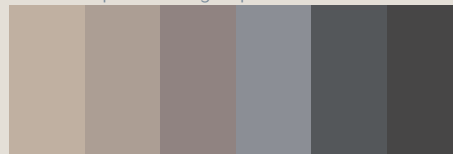

Season

burgundy petal ocean sky forest mint



Ra/NCS







SMART QUIZ COMPLÉMENTS

Grille

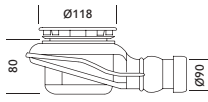

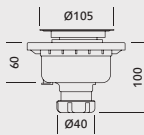
	Texture	Dimensions (cm)	Standard	Nat. Made	Season	Ra/NCS
 Grille Akron	Beton	17,6 x 17,6				

Bondes (mm)

 Bonde standard	 BÂTIMENT - SANITAIRE - ENVIRONNEMENT	
 Bonde de sortie verticale		
 Bonde extraplate		
 Bonde de haut débit		

NOTE: n'est inclus qu'un seul modèle de bonde par receveur de douche.

Matériel d'installation

 Kit d'imperméabilisation de base	Kerdi-TS Schlüter Systems	
 Colle fixation	Ultrabond MS Rapid	
 Silicone pour joints	Mapesil AC	



Découpe sur mesure

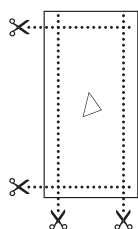

Dimensions

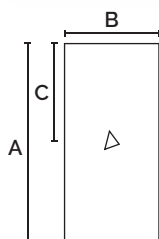

A (cm)	B (cm)	C (cm)
90	90	45
100	70/80/90/100	50
120	70/80/90/100	60
140	70/80/90/100	70
160	70/80/90/100	80
180	70/80/90/100	90
200	70/80/90/100	100

Essais

Texture	Essai	Résultat
QUIZ	UNE-EN 16165:2022 Annexe A	CLASSE B
	Normative française XPP 05-010	PN 18

Fiche technique
du produit



Manuel
d'installation





Tempo Arabba

Tempo Arabba représente un retour aux sources, marqué par le design et l'artisanat. D'aspect textile, il simule les fibres naturelles tissées à la main avec le même soin avec lequel nous fabriquons nos produits. Son motif joue avec notre perception visuelle, se confondant avec une finition en pierre. Une texture fidèle à notre volonté d'être différents.



Dimensions standard (cm)

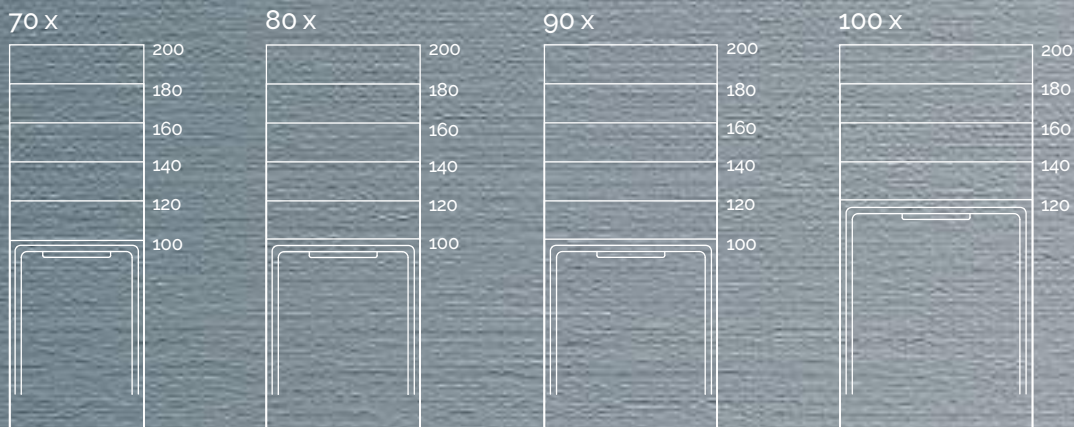







Tempo Arabba



Tempo Arabba blanco 200x100 cm



Couleurs

Standard

blanco nacar beige marfil crema

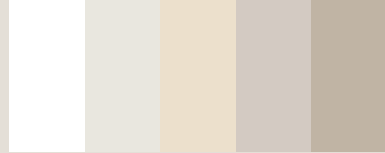

grey cemento moka lava negro

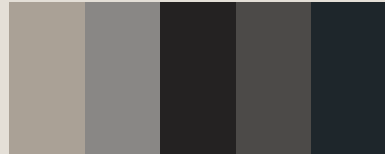

Naturally Made

sand capuccino fango platinum acier ink

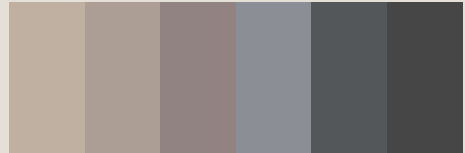

Season

burgundy petal ocean sky forest mint

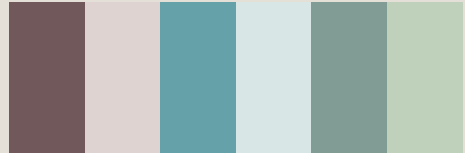





Ra/NCS



TEMPO ARABBA COMPLÉMENTS



Cache bonde

		Texture	Dimensions (cm)	Standard	Nat. Made	Season	RaL/NCS
	Cache bonde Akron	Arabba	34,6 x 2,8				





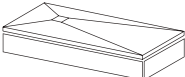

Bonde (mm)

	Bonde line standard						
---	---------------------	--	--	--	--	--	---

Habillage

		Texture	Dimensions (cm)	
	Habillage	Arabba	60 - 200 x 9 x 1,6	

Matériel d'installation

	Kit d'imperméabilisation de base	Kerdi-TS Schlüter Systems	
	Colle fixation	Ultrabond MS Rapid	
	Silicone pour joints	Mapesil AC	



Découpe sur mesure



Dimensions

	A (cm)	B (cm)	C (cm)	D (cm)
	100	70/80/90	7,4	20
	120	70/80/90/100	7,4	20
	140	70/80/90/100	7,4	20
	160	70/80/90/100	7,4	20
	180	70/80/90/100	7,4	20
	200	70/80/90/100	7,4	20

Essais

Texture	Essai	Résultat
ARABBA	UNE-EN 16165:2022 Annexe A	CLASSE C
	Normative française XP P 05-010	PN 24

Fiche technique
du produit



Manuel
d'installation





Flow Zero

Le receveur de douche Flow Zero est conçu pour se fondre dans l'eau. Son design nous plonge dans un univers de calme et de détente grâce à un style minimaliste raffiné. Ses pentes douces, en accord avec la texture Zéro, dirigent l'eau vers une grille intégrée au cadre, capable de gérer le flux important qui s'écoule sur sa surface.



Dimensions standard (cm)

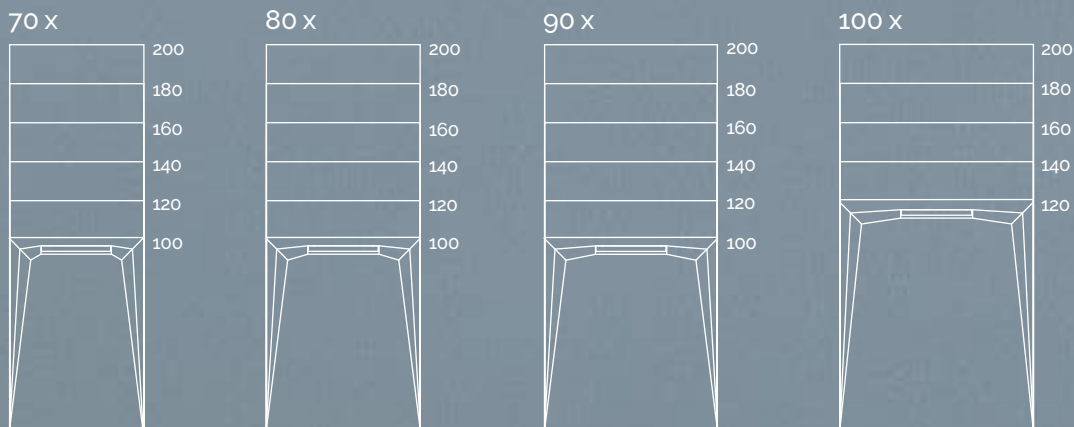







Flow Zero



Flow Zero NCS S 4020-RgOB 200x100 cm



Couleurs

Standard

blanco nacar beige marfil crema

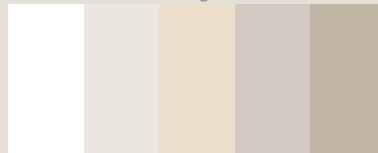

grey cemento moka lava negro

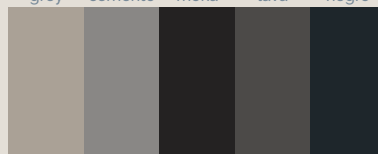

Naturally Made

sand capuccino fango platinum acier ink

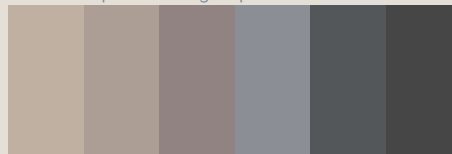

Season

burgundy petal ocean sky forest mint

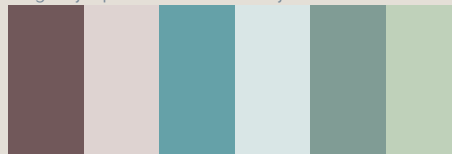





Ra/NCS



FLOW ZERO COMPLÉMENTS



Cache bonde

		Texture	Dimensions (cm)	Standard	Nat. Made	Season	Ra/NCS
	Cache bonde Akron	Zero	36,1 x 3				





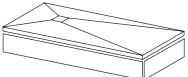

Bonde (mm)

	Bonde line standard						
---	---------------------	--	--	--	--	--	---

Habillage

		Texture	Dimensions (cm)	
	Habillage	Zero	60 - 200 x 9 x 1,6	

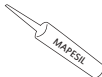
Matériel d'installation

	Kit d'imperméabilisation de base	Kerdi-TS Schlüter Systems	
	Colle fixation	Ultrabond MS Rapid	
	Silicone pour joints	Mapesil AC	



Dimensions

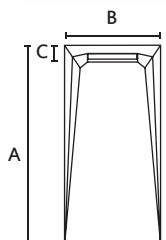

	A (cm)	B (cm)	C (cm)
	100	70/80/90	5,6
	120	70/80/90/100	5,6
	140	70/80/90/100	5,6
	160	70/80/90/100	5,6
	180	70/80/90/100	5,6
	200	70/80/90/100	5,6

Essais

Texture	Essai	Résultat
ZERO	UNE-EN 16165:2022 Annexe A	CLASSE C
	Normative française XP P 05-010	PN 24

Fiche technique
du produit



Manuel
d'installation





Focus Beton

Les tendances sont cycliques, mais les formes géométriques sont toujours présentes dans le design. Acquabella souhaite transmettre ce sentiment d'unité et de perfection à travers le receveur de douche Focus. Combinez la texture de l'aspect ciment Beton avec l'anneau métallique de votre choix dans la zone d'écoulement, afin d'obtenir une harmonie des matériaux.



Dimensions standard (cm)

80 x

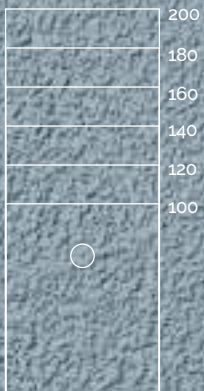

90 x

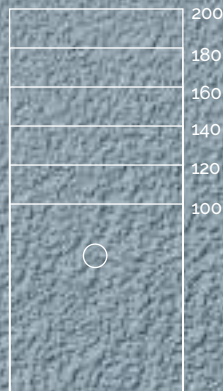

100 x

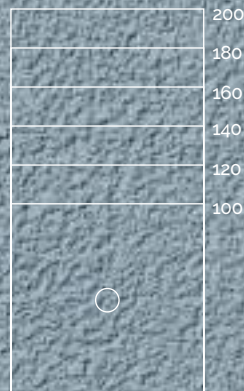

Anneaux de finition disponibles

Inox



Cobre



Negro



Blanco







Focus Beton



Focus cobre Beton blanco 200x100 cm

Couleurs

Standard

blanco nacar beige marfil crema

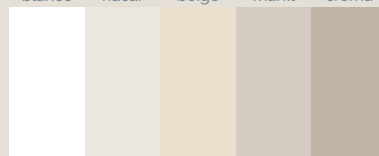

grey cemento moka lava negro

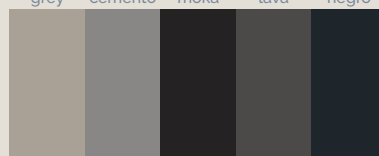

Naturally Made

sand capuccino fango platinum acier ink

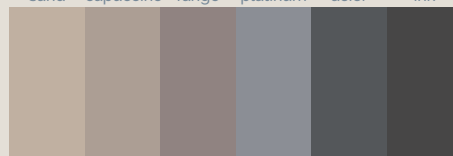

Season

burgundy petal ocean sky forest mint

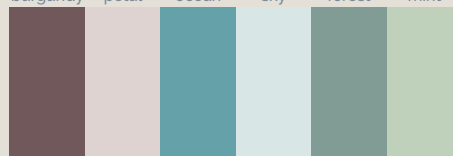











Ra/NCS







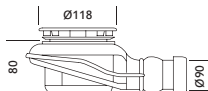

FOCUS BETON COMPLÉMENTS

Grille

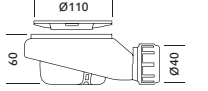

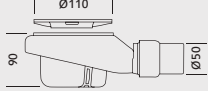
		Texture	Dimensions (cm)	Standard	Nat. Made	Season	Ra/NCS
	Grille Akron	Beton	Ø 10,6				
	Anneau de finition	Inox / Cobre / Negro / Blanco	Ø 12,9				

Bondes (mm)

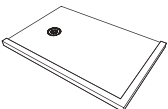

	Bonde standard		
	Bonde de sortie verticale		
	Bonde extraplate		
	Bonde de haut débit		

NOTE: n'est inclus qu'un seul modèle de bonde par receveur de douche.





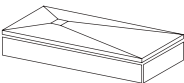

Rebord

		Texture	Dimensions (cm)	
	Rebord	Beton	4,1 x 5	

Habillage

		Texture	Dimensions (cm)	
	Habillage	Beton	60 - 200 x 9 x 1,6	

Matériel d'installation

	Kit d'imperméabilisation de base	Kerdi-TS Schlüter Systems	
	Colle fixation	Ultrabond MS Rapid	
	Silicone pour joints	Mapesil AC	



Découpe sur mesure

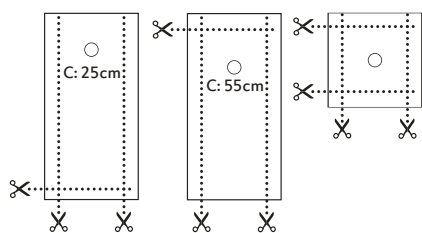

Dimensions

		A (cm)	B (cm)	C (cm)			A (cm)	B (cm)	C (cm)
	C: 25cm	100	80/90	25		C: 55cm	100	100	50
		120	80/90/100	25					
		140	80/90/100	55					
		160	80/90/100	55					
		180	80/90/100	55					
		200	80/90/100	55					

Essais

Texture	Essai	Résultat
BETON	UNE-EN 16165:2022 Annexe A	CLASSE C
	Normative française XPP 05-010	PN 24

Fiche technique
du produit



Manuel
d'installation





Prisma Slate

Des angles élégants font partie du receveur de douche Prisma Slate, créant un jeu d'ombre et de lumière qui ajoute de la valeur au design. La texture de l'ardoise est à l'honneur sur ce receveur de douche sur mesure, qui est couronné d'une grille allongée en acier inoxydable, intégrée dans ses pentes douces.



Dimensions standard (cm)

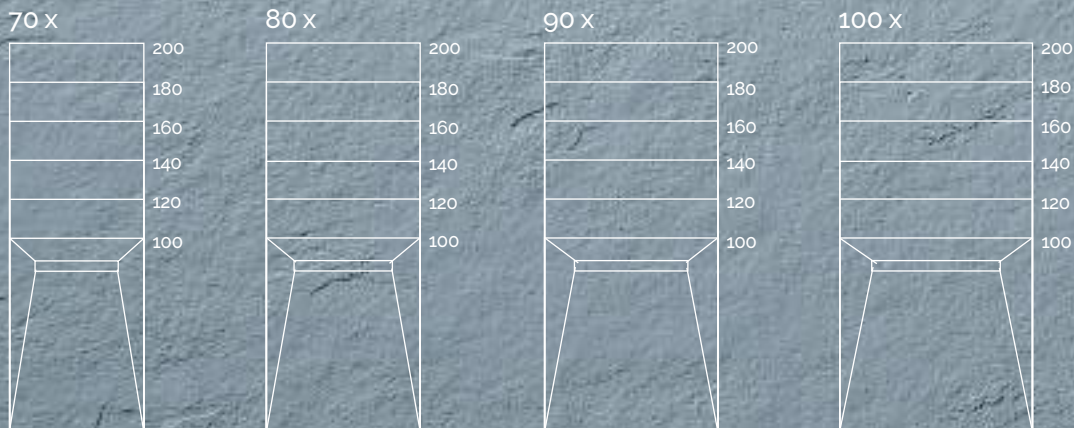



Prisma Slate



Prisma Slate blanco 200x100 cm



Couleurs

Standard

blanco nacar beige marfil crema

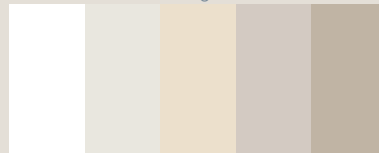

grey cemento moka lava negro

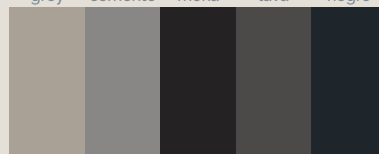

Naturally Made

sand capuccino fango platinum acier ink

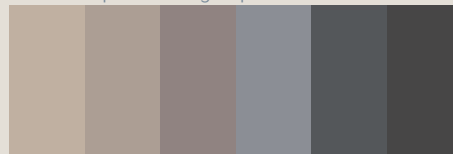

Season

burgundy petal ocean sky forest mint

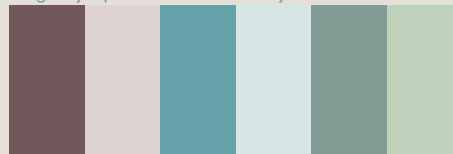

Ra/NCS



PRISMA SLATE COMPLÉMENTS

Grille

		Dimensions (cm)	Standard	Nat. Made	Season	RaL/NCS
	Grille inox	7 x L	<input checked="" type="checkbox"/>	<input checked="" type="checkbox"/>	<input checked="" type="checkbox"/>	<input checked="" type="checkbox"/>

Bondes (mm)

	Bonde standard Ø70					<input checked="" type="checkbox"/>
	Bonde de sortie verticale Ø70					<input checked="" type="checkbox"/>

NOTE: n'est inclus qu'un seul modèle de bonde par receveur de douche.

Rebord

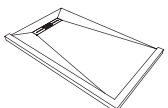
		Texture	Dimensions (cm)	
	Rebord	Slate	4,1 x 5	<input type="checkbox"/>

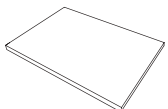

Zone de séchage

		Texture	Dimensions (cm)	
	Zone de séchage	Slate	100 x 100 x 2,3	<input type="checkbox"/>

Habillage

		Texture	Dimensions (cm)	
	Habillage	Slate	60 - 200 x 9 x 1,6	<input type="checkbox"/>

Matériel d'installation

	Kit d'imperméabilisation de base	Kerdi-TS Schlüter Systems	<input type="checkbox"/>
	Colle fixation	Ultrabond MS Rapid	<input type="checkbox"/>
	Silicone pour joints	Mapesil AC	<input type="checkbox"/>



Découpe sur mesure

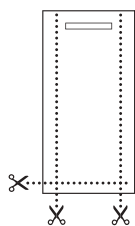

Dimensions

	A (cm)	B (cm)	C (cm)
	100	70/80/90/100	15
	120	70/80/90/100	15
	140	70/80/90/100	25
	160	70/80/90/100	25
	180	70/80/90/100	25
	200	70/80/90/100	25

Essais

Texture	Essai	Résultat
SLATE	UNE-EN 16165:2022 Annexe A	CLASSE C
	Normative française XPP 05-010	PN 24

Fiche technique
du produit



Manuel
d'installation







Baignoires

Opal Quiz 144-149

Lech 150-153

Nevis 154-157

Dewa 158-161

Voss 162-165

Chrea 166-171

Levi 172-175

Vars 176-179

Venet 180-183

Boreal 184-187

Opal Quiz



Baignoire Opal Quiz negro

Couleurs

Standard



Naturally Made

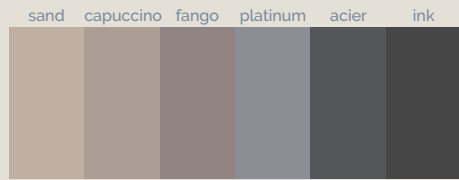

Season

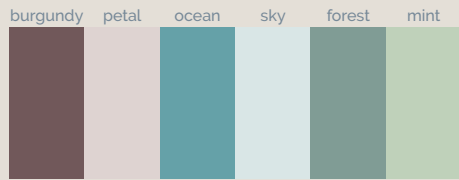

RaI/NCS



Dimensions standard (cm)

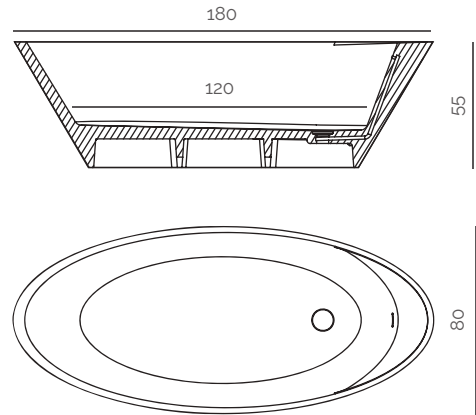

Récompenses



reddot winner 2021





OPAL QUIZ COMPLÉMENTS

Bonde click-clack



Bonde click-clack Akron

Finition

Chrome

Finition cache bonde

Standard / Nat. Made /
Season / Ra/NCS



Bonde (mm)

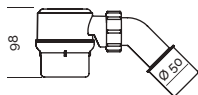

Bonde standard H98



Matériel d'installation



Silicone pour joints

Mapesil AC



OPAL QUIZ INFORMATION TECHNIQUE



Kg

Poids de la baignoire (Kg)

158



L

Volume d'eau à déborder (L)

222

Fiche technique
du produit



Manuel
d'installation









Couleurs

Standard

blanco mate





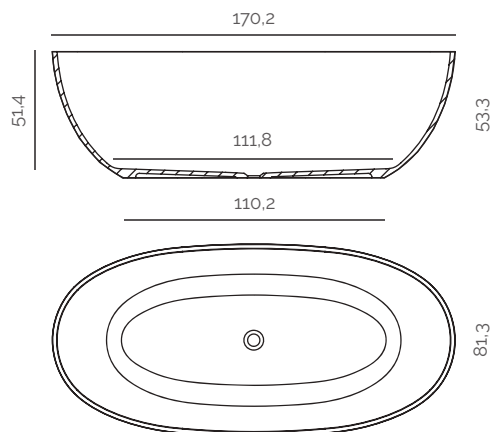

Dimensions standard (cm)



LECHCOMPLÉMENTS



Bonde click-clack

		Finition	Finition cache bonde	
	Bonde click-clack	Chrome	Blanco mate	
	Bonde click-clack	Chrome	Chrome	

Bonde (mm)

	Bonde standard H98			
---	--------------------	--	--	---

Matériel d'installation

	Silicone pour joints	Mapesil AC	
---	----------------------	------------	---

LECHINFORMATION TECHNIQUE

	Poids de la baignoire (Kg)	86,54
	Volume d'eau (L)	427

Fiche technique
du produit



Manuel
d'installation





Nevis



Couleurs

Standard

blanco mate



Dimensions standard (cm)

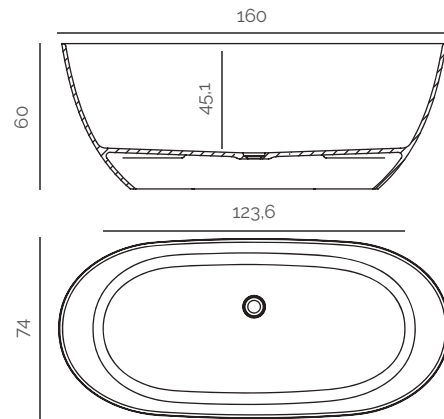

NEVISCOMPLÉMENTS

Bonde click-clack



Bonde click-clack Dolotek

Finition

Chrome

Finition cache bonde

Blanco mate



Bonde (mm)

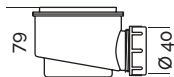

Bonde standard H79



Matériel d'installation



Silicone pour joints

Mapesil AC



NEVISINFORMATION TECHNIQUE



Poids de la baignoire (Kg) **94,40**



Volume d'eau (L) **375**

Fiche technique
du produit



Manuel
d'installation





Dewa



Couleurs

Standard

blanco mate



Dimensions standard (cm)

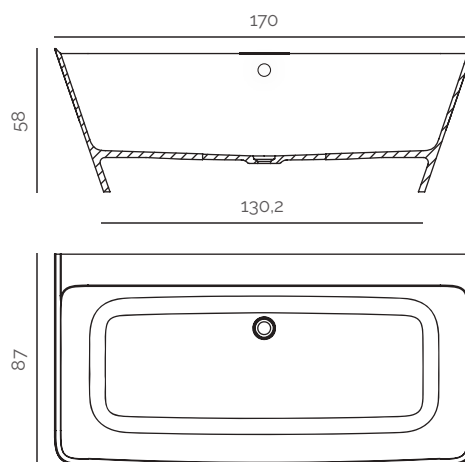

DEWACOMPLÉMENTS

Bonde click-clack



Bonde click-clack Dolotek

Finition

Chrome

Finition cache bonde

Blanco mate



Bonde (mm)

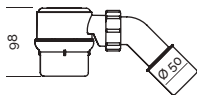

Bonde standard Hg8



Matériel d'installation



Silicone pour joints

Mapesil AC



DEWAINFORMATION TECHNIQUE



Kg

Poids de la baignoire (Kg)

133,11



L

Volume d'eau à déborder (L)

263

Fiche technique
du produit



Manuel
d'installation







Couleurs

Standard

blanco mate



Dimensions standard (cm)

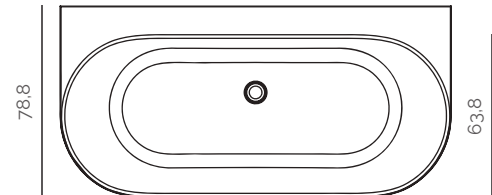
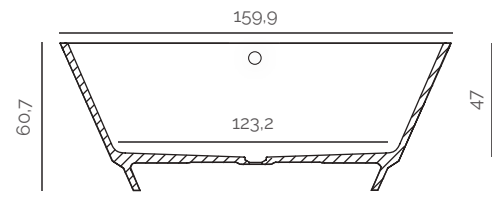

VOSSCOMPLÉMENTS

Bonde click-clack



Bonde click-clack Dolotek

Finition

Chrome

Finition cache bonde

Blanco mate



Bonde (mm)

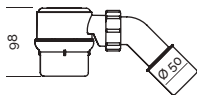

Bonde standard Hg8



Matériel d'installation



Silicone pour joints

Mapesil AC



VOSSINFORMATION TECHNIQUE



Kg

Poids de la baignoire (Kg)

129,45



L

Volume d'eau à déborder (L)

246

Fiche technique
du produit



Manuel
d'installation





Chrea



Baignoire Chrea · Panneaux Hera Zero NCS S 1020-B90G 100x90 cm · Panneaux Basic Slate NCS S 1020-B90G 100x70 cm

Couleurs

Standard

blanco mate



Dimensions standard (cm)

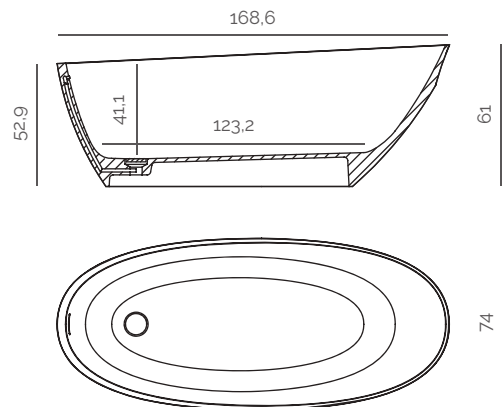





CHREACOMPLÉMENTS

Bonde click-clack



Bonde click-clack Dolotek

Finition

Chrome

Finition cache bonde

Blanco mate



Bonde (mm)

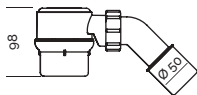

Bonde standard Hg8



Matériel d'installation



Silicone pour joints

Mapesil AC



CHREAINFORMATION TECHNIQUE



Poids de la baignoire (Kg)

121,40



Volume d'eau à déborder (L)

226

Fiche technique
du produit



Manuel
d'installation









Couleurs

Standard

blanco mate





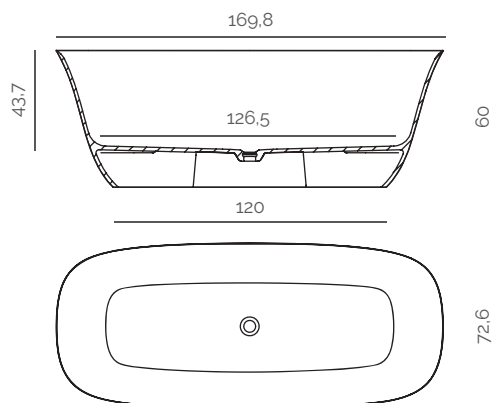

Dimensions standard (cm)



LEVICOMPLÉMENTS



Bonde click-clack

		Finition	Finition cache bonde	
	Bonde click-clack	Chrome	Blanco mate	
	Bonde click-clack	Chrome	Chrome	

Bonde (mm)

	Bonde standard H98			
---	--------------------	--	--	---

Matériel d'installation

	Silicone pour joints	Mapesil AC	
---	----------------------	------------	---

LEVIINFORMATION TECHNIQUE

	Poids de la baignoire (Kg)	121,72
	Volume d'eau (L)	350

Fiche technique
du produit



Manuel
d'installation





Vars



Baignoire Vars · Panneaux Hera Slate NCS S 0530-Y80R 100x90 cm · Panneaux Basic Slate NCS S 0530-Y80R 100x70 cm

Couleurs

Standard

blanco mate



Dimensions standard (cm)

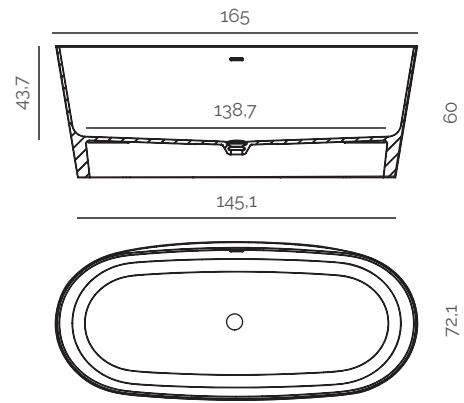

VARSCOMPLÉMENTS

Bonde click-clack



Bonde click-clack Dolotek

Finition

Chrome

Finition cache bonde

Blanco mate



Bonde (mm)

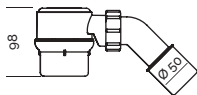

Bonde standard Hg8



Matériel d'installation



Silicone pour joints

Mapesil AC



VARSinFORMATION TECHNIQUE



Kg

Poids de la baignoire (Kg)

110,60



L

Volume d'eau à déborder (L)

300

Fiche technique
du produit



Manuel
d'installation





Venet



Baignoire Venet



Couleurs

Standard

blanco mate



Dimensions standard (cm)

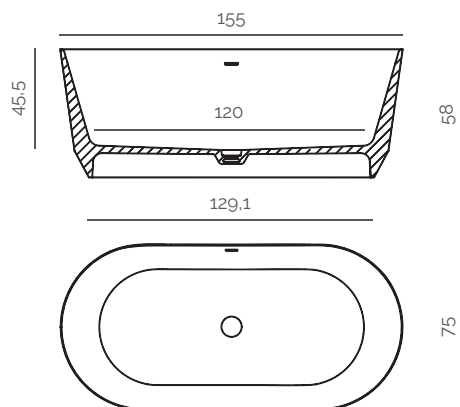

VENETCOMPLÉMENTS

Bonde click-clack



Bonde click-clack Dolotek

Finition

Chrome

Finition cache bonde

Blanco mate



Bonde (mm)

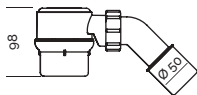

Bonde standard Hg8



Matériel d'installation



Silicone pour joints

Mapesil AC



VENETINFORMATION TECHNIQUE



Poids de la baignoire (Kg)

192,84



Volume d'eau à déborder (L)

298

Fiche technique
du produit



Manuel
d'installation





Boreal



Couleurs

Standard

blanco mate



Dimensions standard (cm)

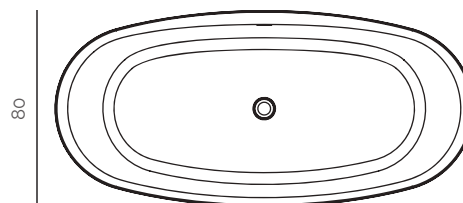
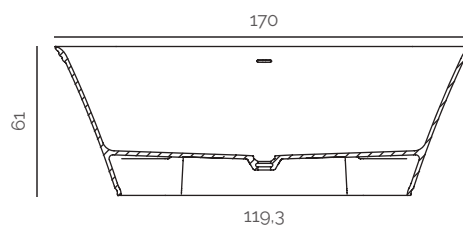

BOREALCOMPLÉMENTS

Bonde click-clack



Bonde click-clack Dolotek

Finition

Chrome

Finition cache bonde

Blanco mate



Bonde (mm)

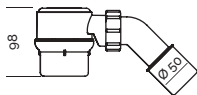

Bonde standard Hg8



Matériel d'installation



Silicone pour joints

Mapesil AC



BOREALINFORMATION TECHNIQUE



Kg

Poids de la baignoire (Kg)

110,50



L

Volume d'eau à déborder (L)

290

Fiche technique
du produit



Manuel
d'installation







Panneaux

Basic 190-193

Quiz 194-197

Hera 198-201

Muretto Vintage 202-205

Muretto Loft 206-209



Basic



Textures

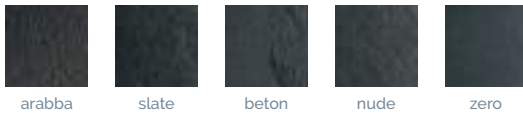

Couleurs

Standard



Naturally Made

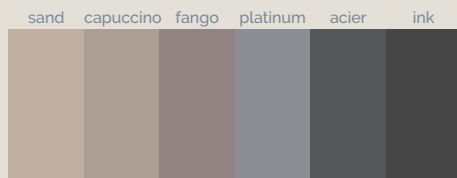

Season

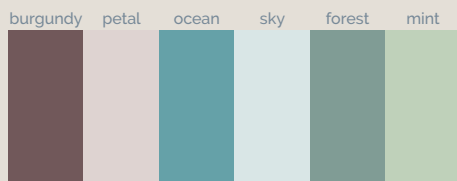

RaL/NCS





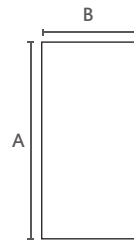



Dimensions standard (cm)





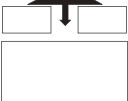

A	B
200	70/80/90/100/120
220	70/80/90/100/120
250	70/80/90/100/120

BASICCOMPLÉMENTS

Profils

		Finition	
	Profil definition	Chrome	
	Profil d'angle	Chrome	
	Profil intermédiaire entre panneaux	Chrome	

Matériel d'installation

	Colle fixation	Ultrabond MS Rapid	
	Silicone pour joints	Mapesil AC	

Fiche technique
du produit



Manuel
d'installation





Quiz



Panneaux Quiz blanco 250x120 cm · Plan de toilette One CF Beton crema 240x50 cm · Vasques On-Top Colors Circle XL Beton NCS S 3050-Y80R · Mirrors Moon Beton NCS S 3050-Y80R · Meubles Show go Quiz NCS S 3050-Y80R · Armoire Show Quiz NCS S 3050-Y80R

Texture



quiz

Couleurs

Standard

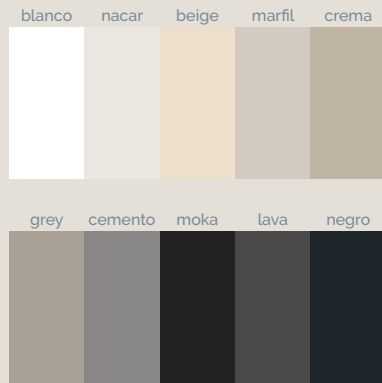

Naturally Made

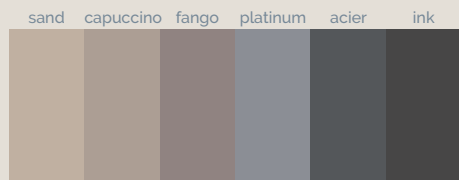

Season

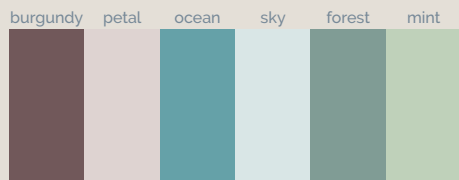

RaL/NCS





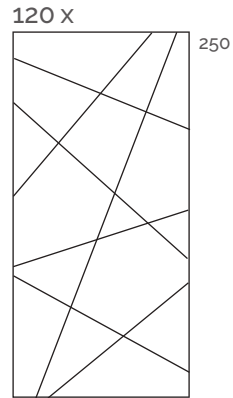



Dimensions standard (cm)





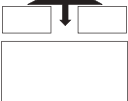

QUIZCOMPLÉMENTS

Profils

		Finition	
	Profil definition	Chrome	
	Profil d'angle	Chrome	
	Profil intermédiaire entre panneaux	Chrome	

Matériel d'installation

	Colle fixation	Ultrabond MS Rapid	
	Silicone pour joints	Mapesil AC	

QUIZINFORMATION TECHNIQUE

Installation

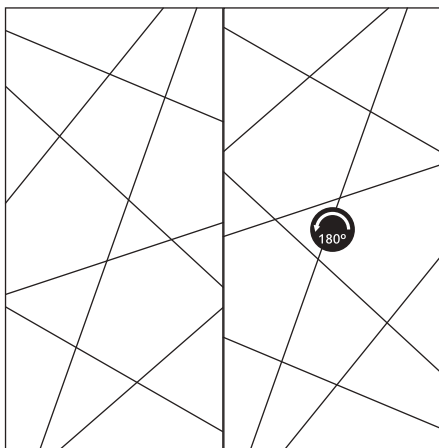

Fiche technique
du produit



Manuel
d'installation





Hera



Panneaux Hera Zero capuccino 250x100 cm

Texture



zero



Couleurs

Standard

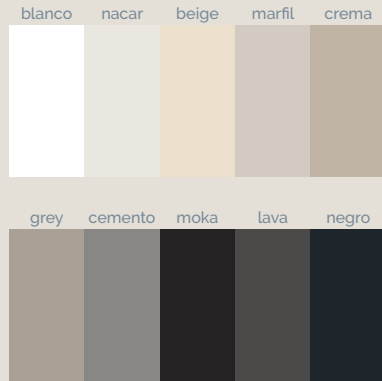

Naturally Made

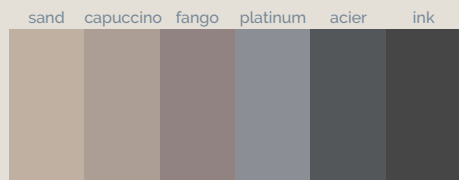

Season

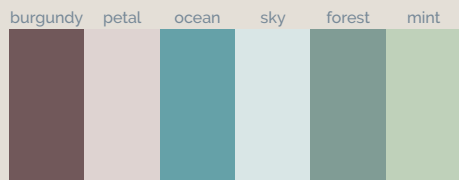

RaL/NCS



Dimensions standard (cm)

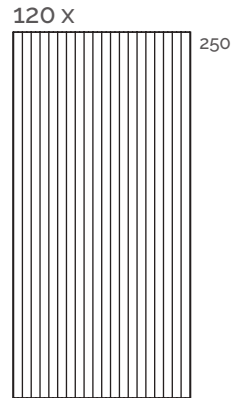

HERACOMPLÉMENTS

Matériel d'installation



Colle fixation

Ultrabond MS Rapid

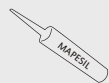

Silicone pour joints

Mapesil AC



HERAINFORMATION TECHNIQUE

Installation

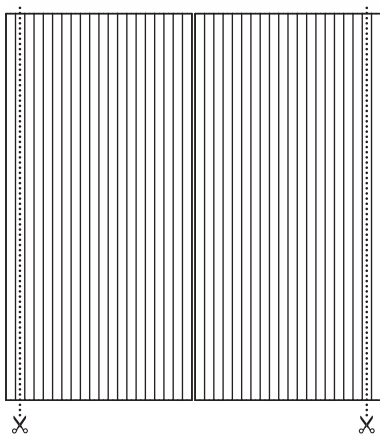

Fiche technique
du produit



Manuel
d'installation





Muretto Vintage





Couleurs

Standard



Naturally Made

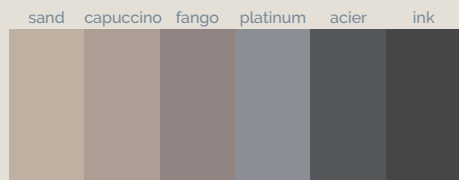

Season

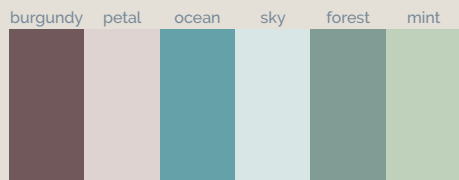

RaI/NCS



Dimensions standard (cm)

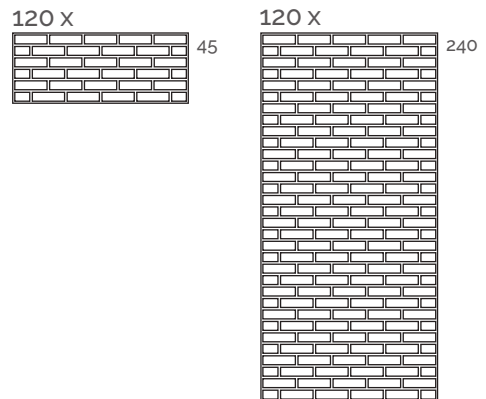

MURETTO VINTAGE COMPLÉMENTS

Matériel d'installation



Colle fixation

Ultrabond MS Rapid



Silicone pour joints

Mapesil AC



MURETTO VINTAGE INFORMATION TECHNIQUE

Installation

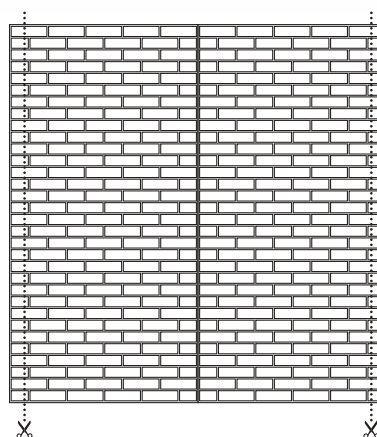
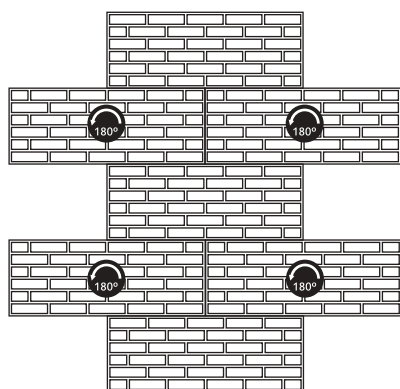

Fiche technique
du produit

Manuel
d'installation





Muretto Loft



Muretto Loft XL NCS S 4030-Y80R 250x120 cm

Texture



beton

Couleurs

Standard

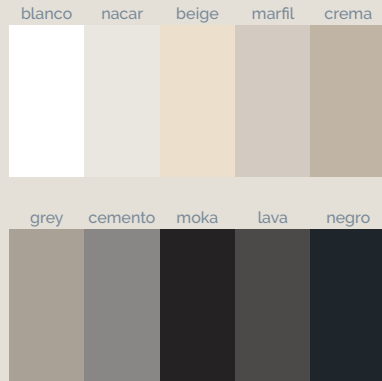

Naturally Made

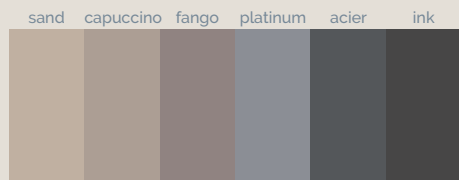

Season

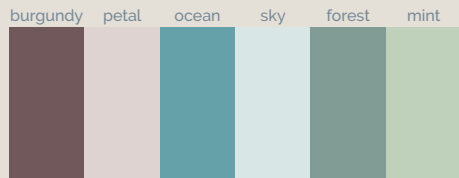

RaI/NCS



Dimensions standard (cm)

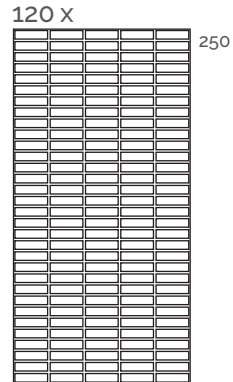

MURETTO LOFT COMPLÉMENTS

Matériel d'installation



Colle fixation

Ultrabond MS Rapid



Silicone pour joints

Mapesil AC



MURETTO LOFT INFORMATION TECHNIQUE

Installation

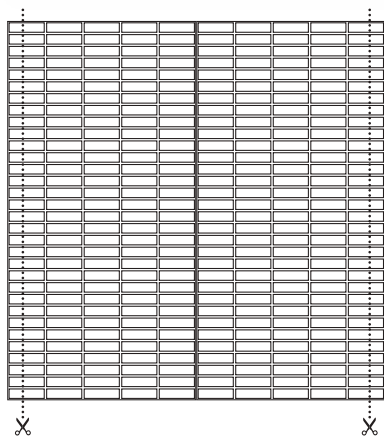

Fiche technique
du produit

Manuel
d'installation









Plans de toilette

Integra 212-217

Integra 2 218-221

Mini 222-225

Infinity 226-229

Infinity 2 230-235

One 236-239

Moiwa 240-243

Integra



Plan de toilette Integra CF 120 DX Slate NCS S 3030-Y80R



slate

Couleurs

Standard

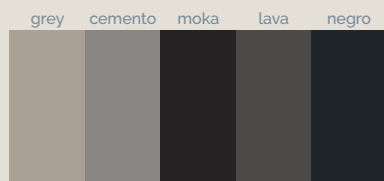
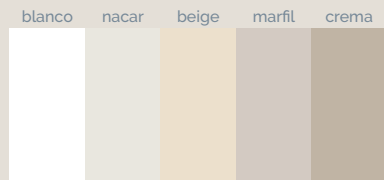

Naturally Made

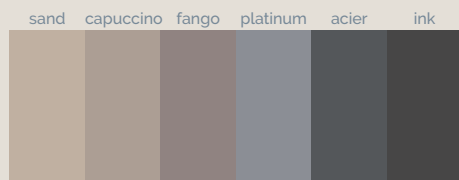

Season

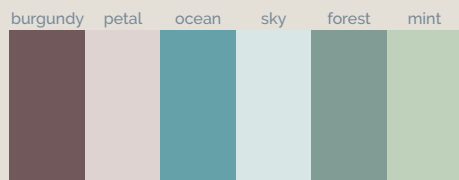

RaI/NCS



Dimensions standard (cm)

Integra 60

SF: 60,3 / CF: 60

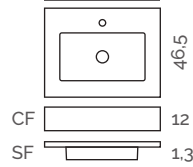

Integra 80

SF: 80,3 / CF: 80

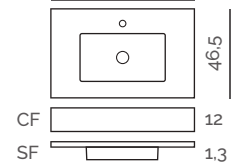

Integra 90

SF: 90,3 / CF: 90

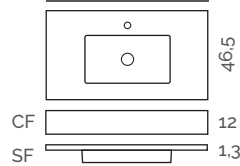

Integra 100

SF: 100,3 / CF: 100

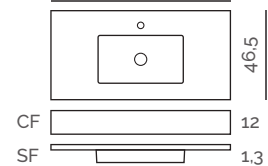

Integra 100 Sx

SF: 100,3 / CF: 100

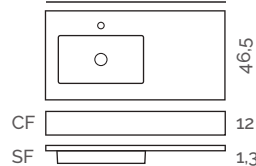

Integra 100 Dx

SF: 100,3 / CF: 100

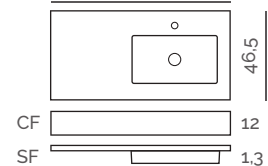

Integra 120

SF: 120,3 / CF: 120

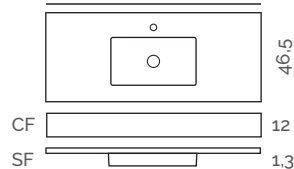

Integra 120 Sx

SF: 120,3 / CF: 120

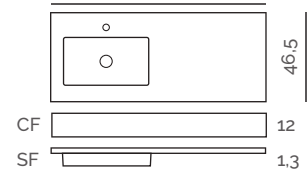

Integra 120 Dx

SF: 120,3 / CF: 120

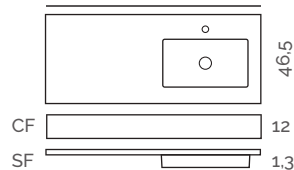

Integra 120 XL

SF: 120,3 / CF: 120

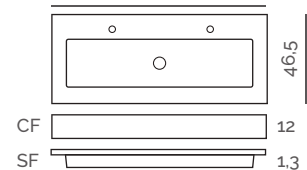











INTEGRACOMPLÉMENTS



Vasques

	Dimensions (cm)	Integra 60	Integra 80	Integra 90	Integra 100	Integra 120	Integra 120 XL
	26,7 x 50 x 9	✓	✓	✓	✓	✓	
	26,7 x 104 x 9						✓



Bondes click-clack

		Finition	
	Bonde click-clack Akron	Chrome / Noir	
	Bonde à écoulement Akron	Chrome / Noir	

Socle

		Texture	Dimensions (cm)	
	Socle	Slate	60 - 120 x 3 x 1,6	

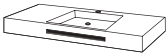



Porte-serviettes

		Dimensions (cm)	Integra CF
	Porte-serviettes Show frontale	40 x 4	

Système de fixation

		Integra SF	Integra CF
	Système de fixation		✓

Matériel d'installation

	Colle fixation	Ultrabond MS Rapid	
	Silicone pour joints	Mapesil AC	

Fiche technique
du produit



Manuel
d'installation





Integra 2



Plan de toilette Integra 2 CF 140 Slate capuccino · Panneaux Basic Slate blanco 250x100 cm · Miroir Urban



slate

Couleurs

Standard

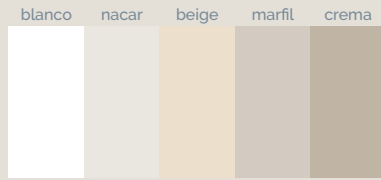

Naturally Made

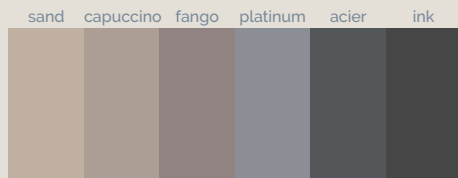

Season

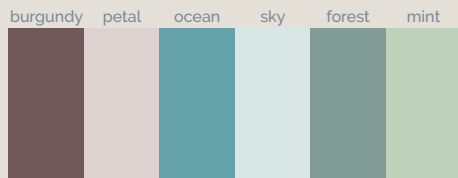

RaI/NCS



Dimensions standard (cm)

Integra-2 120

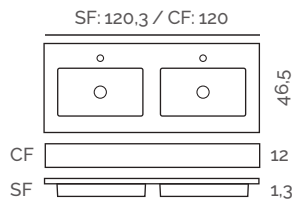

Integra-2 140

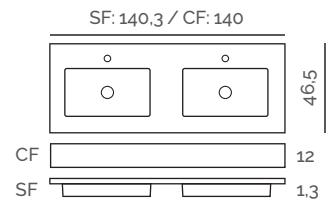

INTEGRA 2 COMPLÉMENTS

Vasque

	Dimensions (cm)	Integra-2 120	Integra-2 140
	26,7 x 50 x 9	<input checked="" type="checkbox"/>	<input checked="" type="checkbox"/>

Bondes click-clack

		Finition	
	Bonde click-clack Akron	Chrome / Noir	<input type="checkbox"/>
	Bonde à écoulement Akron	Chrome / Noir	<input type="checkbox"/>

Socle

		Texture	Dimensions (cm)	
	Socle	Slate	120 - 140 x 3 x 1,6	<input type="checkbox"/>

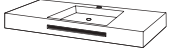

Porte-serviettes

		Dimensions (cm)	Integra-2 CF
	Porte-serviettes Show frontale	40 x 4	<input type="checkbox"/>

Système de fixation

		Integra-2 SF	Integra-2 CF
	Système de fixation		<input checked="" type="checkbox"/>

Matériel d'installation

	Colle fixation	Ultrabond MS Rapid	<input type="checkbox"/>
	Silicone pour joints	Mapesil AC	<input type="checkbox"/>

Fiche technique
du produit



Manuel
d'installation





Mini



Plans de toilette Mini Slate blanco · Panneau Basic Slate NCS S 4020-R90B 250x120 cm · Miroir Urban

Texture



slate

Couleurs

Standard

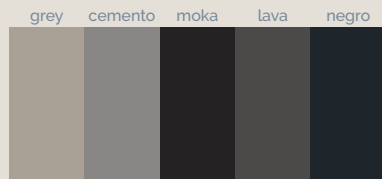
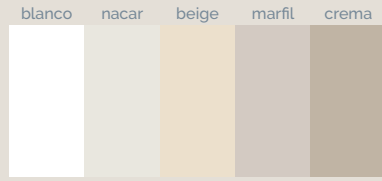

Naturally Made

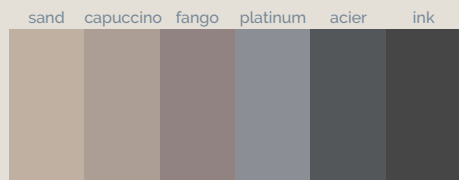

Season

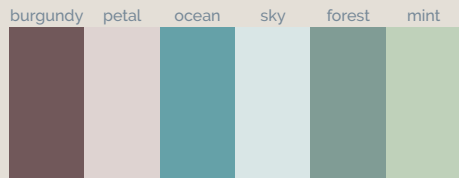

RaI/NCS



Dimensions standard (cm)

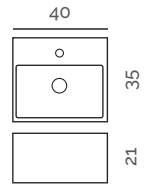

MINICOMPLÉMENTS

Vasque

Dimensions (cm)



23,4 x 38 x 12,1



Bondes click-clack

Finition



Bonde click-clack
Akron

Chrome /
Noir



Bonde à écoulement
Akron

Chrome /
Noir



Système de fixation

Finition

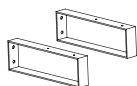

Système de fixation

Acier poli / Noir



Matériel d'installation



Colle fixation

Ultrabond MS Rapid



Silicone pour joints

Mapesil AC



Fiche technique
du produit

Manuel
d'installation





Infinity



Plan de toilette Infinity 52 CF Arabba capuccino 200x50 cm

Textures

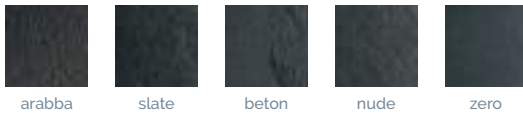

Couleurs

Standard

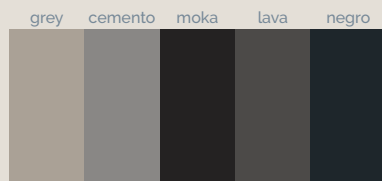
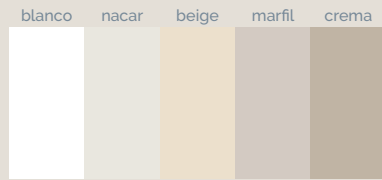

Naturally Made

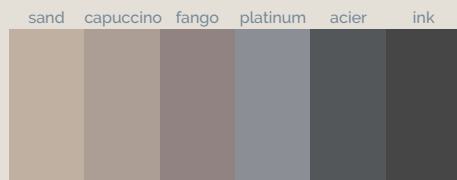

Season

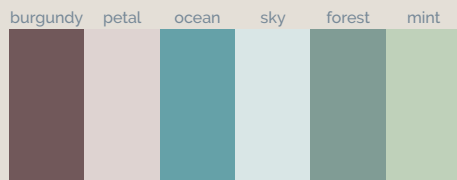

RaI/NCS



Dimensions standard (cm)

Infinity 42

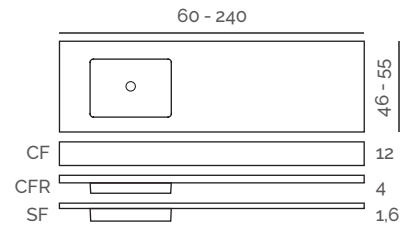

Infinity 52

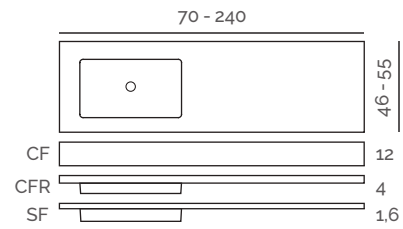

Infinity Round 52

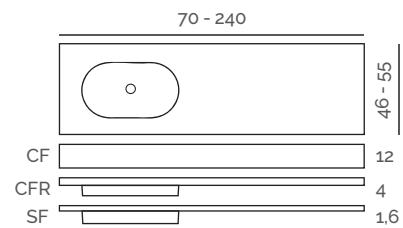

Infinity 62

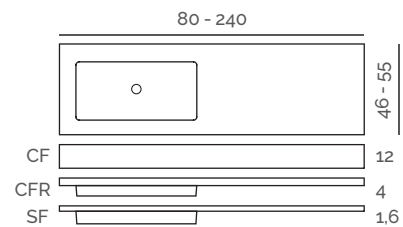





NOTE: il est nécessaire de joindre un croquis coté à chaque commande d'un plan de toilette.

Formulaire de
commando







INFINITYCOMPLÉMENTS



Vasques

		Dimensions (cm)	Dimensions plan de toilette	Infinity 42	Infinity 52	Infinity 62
	Vasque 42	30 x 42 x 10	Infinity 60 - 240	✓		
	Vasque 52	30 x 52 x 10	Infinity 70 - 240		✓	
	Vasque 52 Round	30 x 52 x 10	Infinity 70 - 240		✓	
	Vasque 62	30 x 62 x 10	Infinity 80 - 240			✓







Bondes click-clack

		Finition	
	Bonde click-clack Akron	Chrome / Noir	
	Bonde à écoulement Akron	Chrome / Noir	

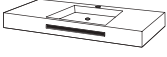
Socle

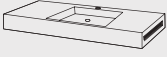
		Texture	Dimensions (cm)	
	Socle	Arabba / Slate / Beton / Nude / Zero	60 - 240 x 3 x 1,6	

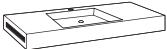
Porte-serviettes

		Dimensions (cm)	Infinity CF
	Porte-serviettes Show frontale	40 x 4	
	Porte-serviettes Show droit	40 x 4	
	Porte-serviettes Show gauche	40 x 4	

Système de fixation

		Infinity CF	Infinity CFR	Infinity SF
	Système de fixation	✓	✓	

Fiche technique
du produit



Manuel
d'installation



Matériel d'installation



Colle fixation

Ultrabond MS Rapid



Silicone pour joints

Mapesil AC



Infinity 2



Plan de toilette Infinity 2 Round 52 CF Beton platinum 220x46 cm

Textures

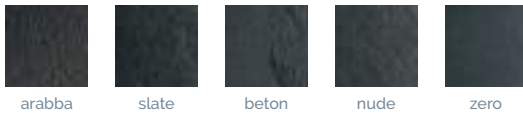

Couleurs

Standard

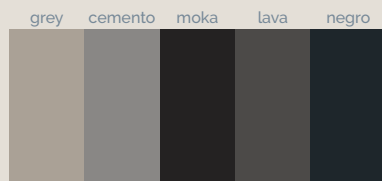
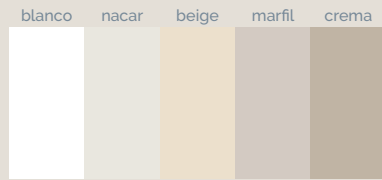

Naturally Made

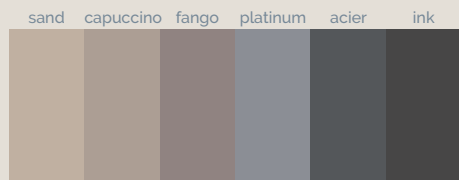

Season

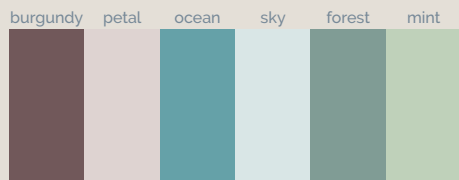

RaI/NCS



Dimensions standard (cm)

Infinity-2 42

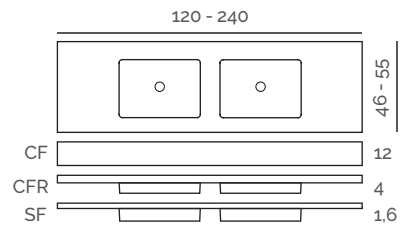

Infinity-2 52

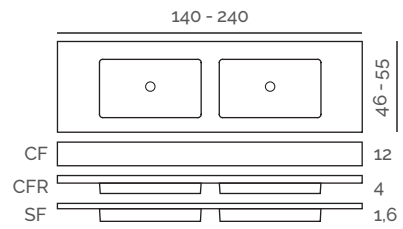

Infinity-2 Round 52

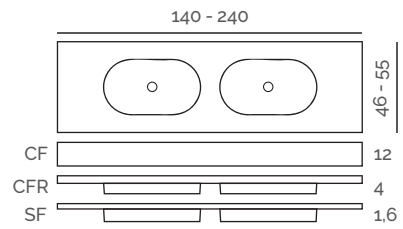

Infinity-2 62

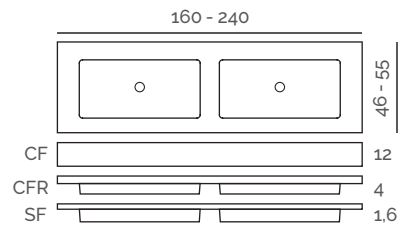

NOTE: il est nécessaire de joindre un croquis coté à chaque commande d'un plan de toilette.

Formulaire de commando











INFINITY 2 COMPLÉMENTS



Vasques

		Dimensions (cm)	Dimensions plan de toilette	Infinity-2 42	Infinity-2 52	Infinity-2 62
	Vasque 42	30 x 42 x 10	Infinity-2 120 - 240	✓		
	Vasque 52	30 x 52 x 10	Infinity-2 140 - 240		✓	
	Vasque 52 Round	30 x 52 x 10	Infinity-2 140 - 240		✓	
	Vasque 62	30 x 62 x 10	Infinity-2 160 - 240			✓







Bondes click-clack

		Finition	
	Bonde click-clack Akron	Chrome / Noir	
	Bonde à écoulement Akron	Chrome / Noir	

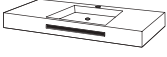
Socle

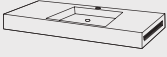
		Texture	Dimensions (cm)	
	Socle	Arabba / Slate / Beton / Nude / Zero	120 - 240 x 3 x 1,6	

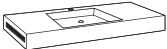
Porte-serviettes

		Dimensions (cm)	Infinity-2 CF
	Porte-serviettes Show frontale	40 x 4	
	Porte-serviettes Show droit	40 x 4	
	Porte-serviettes Show gauche	40 x 4	

Système de fixation

		Infinity-2 CF	Infinity-2 CFR	Infinity-2 SF
	Système de fixation	✓	✓	

Fiche technique
du produit



Manuel
d'installation



Matériel d'installation



Colle fixation

Ultrabond MS Rapid



Silicone pour joints

Mapesil AC



One



Plan de toilette One CF Beton sky 180x50 cm

Textures

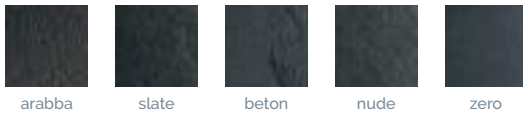

Couleurs

Standard

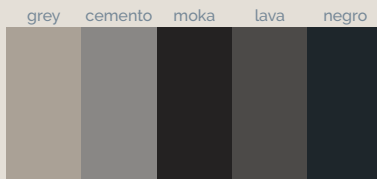
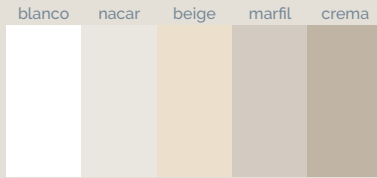

Naturally Made

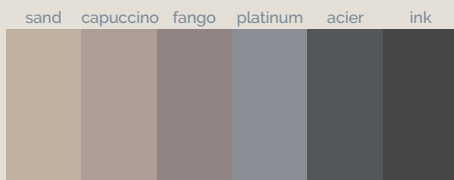

Season

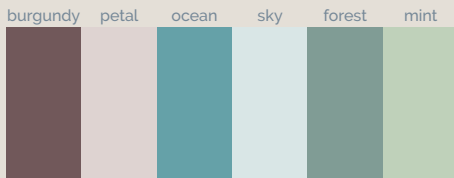

RaL/NCS



Dimensions standard (cm)

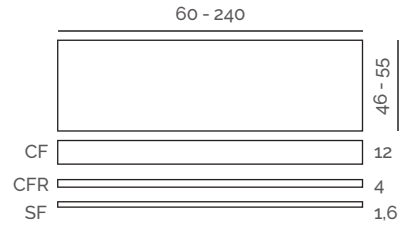



NOTE: il est nécessaire de joindre un croquis coté à chaque commande d'un plan de toilette.

Formulaire de
commando







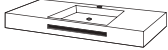

ONECOMPLÉMENTS

Socle

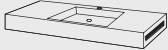
	Texture	Dimensions (cm)	
 Socle	Arabba / Slate / Beton / Nude / Zero	60 - 120 x 3 x 1,6	

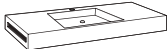



Porte-serviettes

	Dimensions (cm)	
 Porte-serviettes Show frontale	40 x 4	One CF 
 Porte-serviettes Show droit	40 x 4	
 Porte-serviettes Show gauche	40 x 4	

Système de fixation

	One CF	One CFR	One SF
 Système de fixation			

Matériel d'installation

 Colle fixation	Ultrabond MS Rapid	
 Silicone pour joints	Mapesil AC	

Fiche technique
du produit



Manuel
d'installation







Couleurs

Standard

blanco mate



Dimensions standard (cm)

Moiwa 81

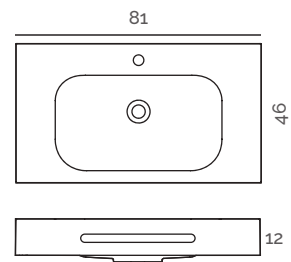

Moiwa 91

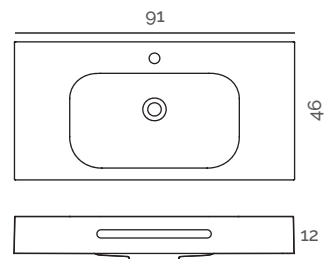

Moiwa 101

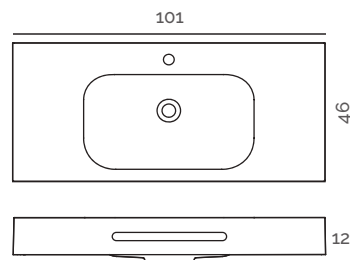



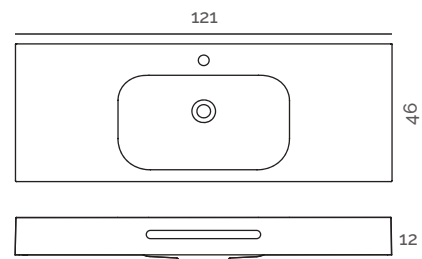





Moiwa 121





MOIWA COMPLÉMENTS

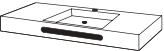

Bondes click-clack et de livre écoulement

		Finition	Finition cache bonde	
	Bonde click-clack	Chrome	Chrome	
	Bonde à écoulement livre	Chrome	Chrome	
	Bonde Pop Down	Chrome	Chrome	
	Bonde plate	Chrome	Chrome	

Porte-serviettes

		Dimensions (cm)	
	Porte-serviettes Moiva	50 x 5	

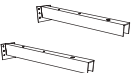
Système de fixation

	Système de fixation		
---	---------------------	--	---

Matériel d'installation

	Silicone pour joints	Mapesil AC	
---	----------------------	------------	---

Fiche technique
du produit



Manuel
d'installation









Vasques

Delia 246-249

On-Top 250-255

Chrea 256-259

Levi 260-263

Vars 264-267

Venet 268-271

Delia



Vasque Delia Zero forest

Texture



zero

Couleurs

Standard

blanco nacar beige marfil crema

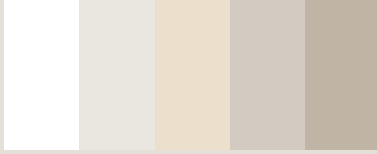

grey cemento moka lava negro

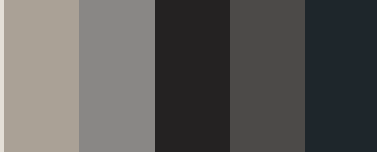

Naturally Made

sand capuccino fango platinum acier ink

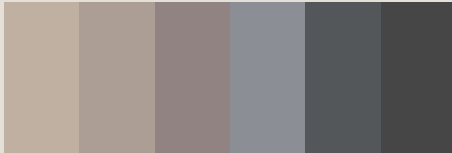

Season

burgundy petal ocean sky forest mint

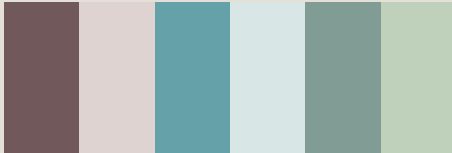

RaI/NCS



Dimensions standard (cm)

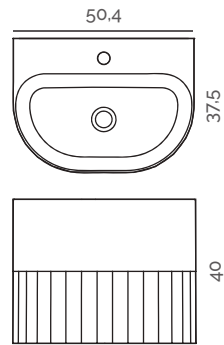

Récompense



archiproducts
DESIGN AWARDS
2022

WINNER

DELIACOMPLÉMENTS

Bondes click-clack

		Finition	
	Bonde click-clack Akron	Chrome / Noir	
	Bonde à écoulement Akron	Chrome / Noir	

Système de fixation

	Système de fixation	
---	---------------------	---

Matériel d'installation

	Silicone pour joints	Mapesil AC	
---	----------------------	------------	---

Fiche technique
du produit



Manuel
d'installation





On-Top



Vasques On-top Rectangle XL Beton NCS S 3040-Y60R

Textures



Couleurs

Standard

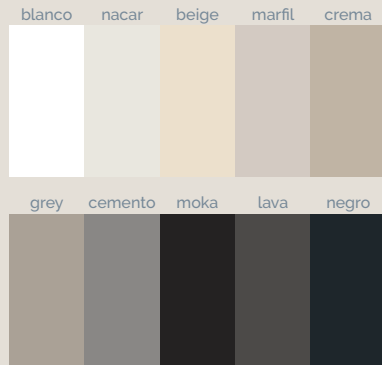

Naturally Made

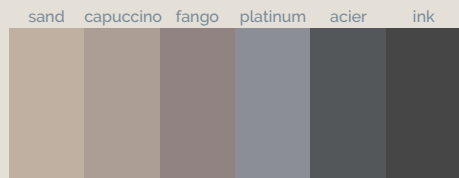

Season

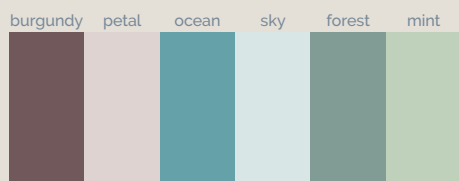

RaI/NCS



Dimensions standard (cm)

On-Top Circle

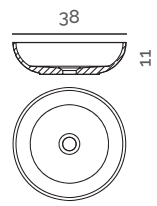

On-Top Circle XL

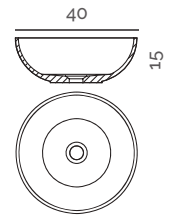

On-Top Square

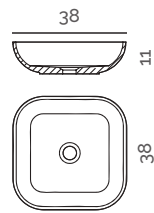

On-Top Square XL

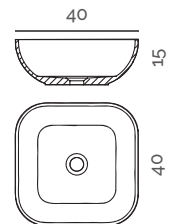

On-Top Oval

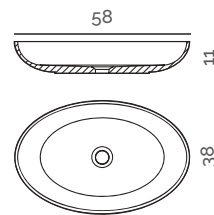

On-Top Oval XL

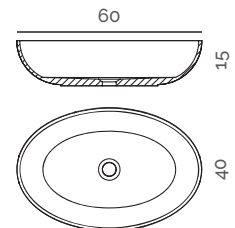

On-Top Rectangle

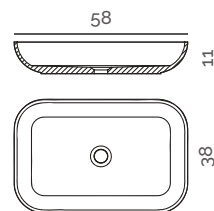

On-Top Rectangle XL

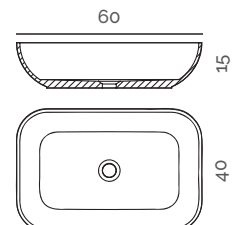

NOTE: bonde de 5 cm de diamètre.





ON-TOPCOMPLÉMENTS

Bondes click-clack et de livre écoulement



Bonde click-clack
Akron

Finition

Chrome /
Noir



Bonde à écoulement
Akron

Chrome /
Noir



Matériel d'installation



Silicone pour joints

Mapesil AC



Fiche technique
du produit



Manuel
d'installation





Chrea





Couleurs

Standard

blanco mate



Dimensions standard (cm)

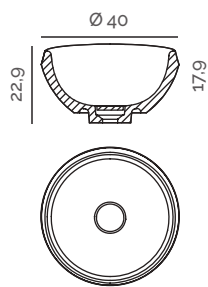

CHREACOMPLÉMENTS

Bonde click-clack



Bonde click-clack Dolotek

Finition

Chrome

Finition cache bonde

Blanco mate



Matériel d'installation



Silicone pour joints

Mapesil AC



Fiche technique
du produit



Manuel
d'installation







Vasque Levi Rectangle

Couleurs

Standard

blanco mate



Dimensions standard (cm)

Levi Circle XL

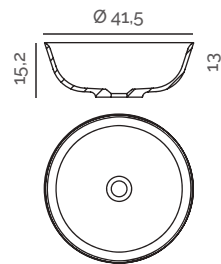

Levi Rectangle

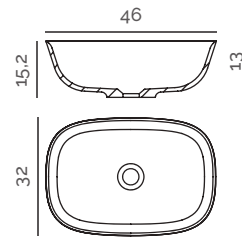



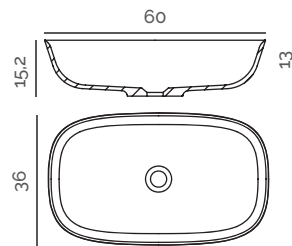





Levi Rectangle XL



LEVICOMPLÉMENTS

Bondes click-clack et de livre écoulement

		Finition	Finition cache bonde	
	Bonde click-clack	Chrome	Chrome	
	Bonde à écoulement livre	Chrome	Chrome	
	Bonde Pop Down	Chrome	Chrome	
	Bonde plate	Chrome	Chrome	

Matériel d'installation



Silicone pour joints

Mapesil AC



Fiche technique
du produit



Manuel
d'installation





Vars



Vasque Vars Rectangle XL

Couleurs

Standard

blanco mate



Dimensions standard (cm)

Vars Circle

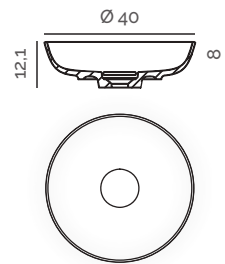

Vars Circle XL

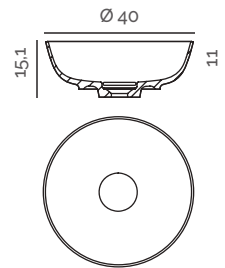

Vars Square XL

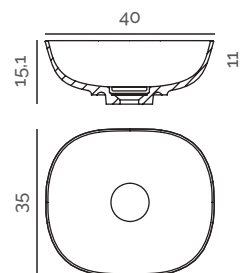

Vars Rectangle XL

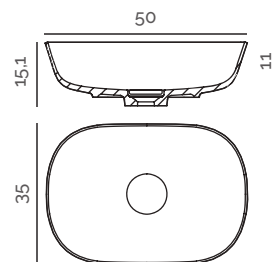

VARSCOMPLÉMENTS

Cache bonde



Cache bonde Dolotek

Matériel

Dolotek

Finition

Blanco mate



Bondes click-clack et de livre écoulement



Bonde Pop Down

Finition

Chrome

Finition cache bonde

Chrome



Bonde plate

Chrome

Chrome



Matériel d'installation



Silicone pour joints

Mapesil AC



Fiche technique
du produit



Manuel
d'installation







Couleurs

Standard

blanco mate



Dimensions standard (cm)

Venet Circle

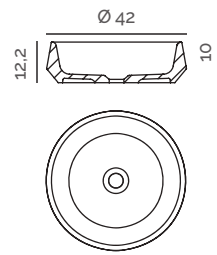

Venet Circle XL

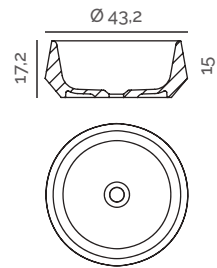

Venet Square

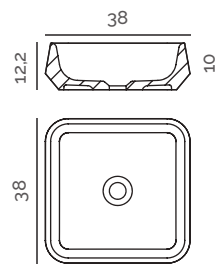



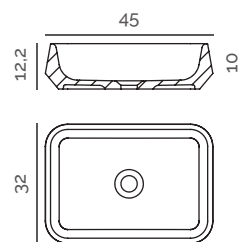





Venet Rectangle



VENETCOMPLÉMENTS

Bondes click-clack et de livre écoulement

		Finition	Finition cache bonde	
	Bonde click-clack	Chrome	Chrome	
	Bonde à écoulement livre	Chrome	Chrome	
	Bonde Pop Down	Chrome	Chrome	
	Bonde plate	Chrome	Chrome	

Matériel d'installation



Silicone pour joints

Mapesil AC



Fiche technique
du produit



Manuel
d'installation









Totems

Icon 274-277

Levi 278-281

Vars 282-285



Texture



slate

Couleurs

Standard

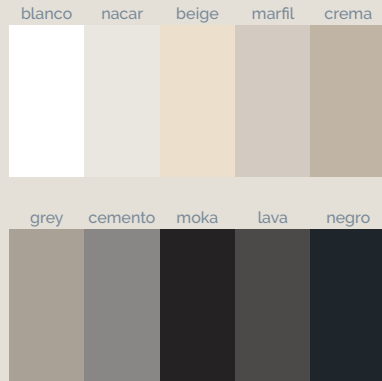

Naturally Made

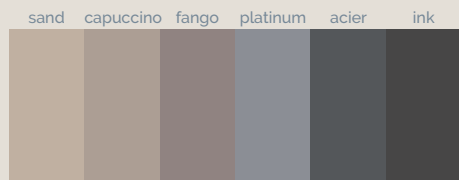

Season

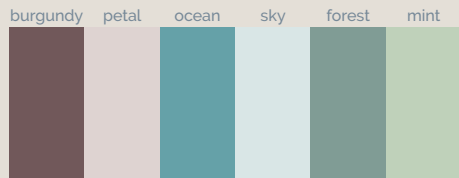

RaI/NCS



Dimensions standard (cm)

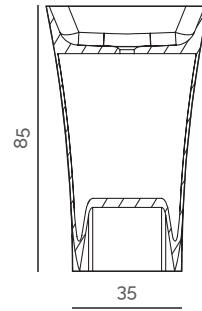
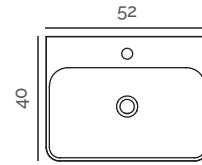

ICONCOMPLÉMENTS

Bondes click-clack



Bonde click-clack
Akron

Finition

Chrome /
Noir



Bonde à écoulement
Akron

Chrome /
Noir



Système de fixation



Système de fixation



Matériel d'installation



Silicone pour joints

Mapesil AC



Fiche technique
du produit



Manuel
d'installation









Couleurs

Standard

blanco mate



Dimensions standard (cm)

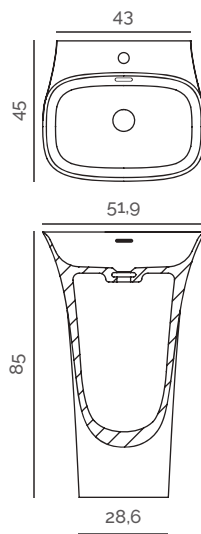

LEVICOMPLÉMENTS

Bonde click-clack



Bonde click-clack avec trop-plein

Finition

Chrome

Finition cache bonde

Chrome



Système de fixation



Système de fixation



Matériel d'installation



Silicone pour joints

Mapesil AC



Fiche technique
du produit



Manuel
d'installation





Totems



Couleurs

Standard

blanco mate



Dimensions standard (cm)

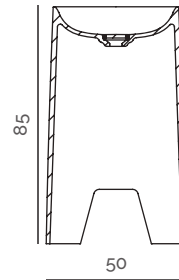
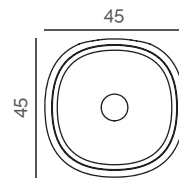

VARSCOMPLÉMENTS

Cache bonde



Cache bonde Dolotek

Matériel

Finition

Dolotek

Blanco mate



Bondes click-clack et de livre écoulement



Bonde Pop Down

Finition

Finition cache bonde

Chrome

Chrome



Bonde plate

Chrome

Chrome



Matériel d'installation



Silicone pour joints

Mapesil AC



Fiche technique
du produit



Manuel
d'installation







Meubles et accessoires

Meuble Artic 288-291

Meuble Delia 292-293

Meuble Integra 294-295

Meuble Integra pose au sol 296-297

Meuble Urban 298-299

Meuble Show 300-301

Armoire Show 302-303

Tabouret Show 304-305

Siège mural Show 306-307

Étagère Box 308-309

Étagère Show 310-311

Étagère Corner Show 312-313

Habillage Bâti 314-315

Miroir Moon 316-317

Miroir Urban 318-319

Miroir Show 320-321

Colonne de douche Kendo 322-323

Meuble Artic



Finitions

madera blanco



Dimensions standard (cm)

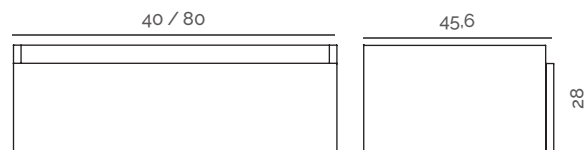

NOTE: plan non compris avec Meuble Artic.

NOTE: le meuble Artic peut être combiné avec n'importe lequel de nos plans de toilette avec une position d'écoulement centrée. Les plans de toilette Infinity et Infinity 2 doivent être sans de trou de robinetterie.

Fiche technique
du produit



Manuel
d'installation







Meuble Delia



Meubles Delia Slate capuccino · Vasques Delia Zero capuccino

Textures

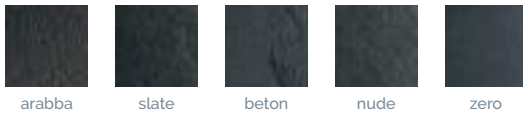

Couleurs

Standard

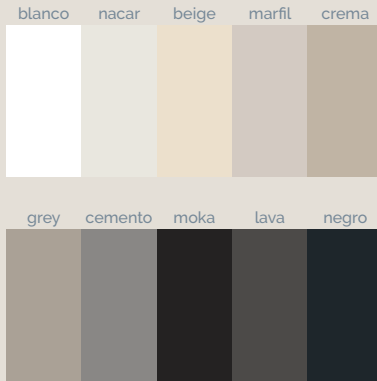

Naturally Made

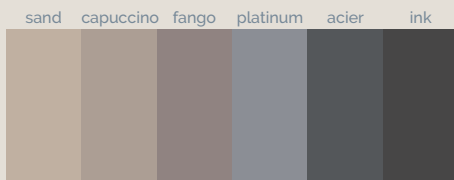

Season

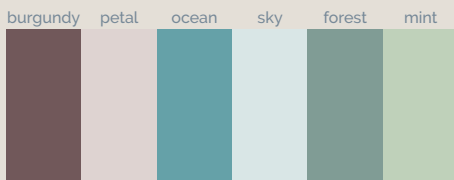

RaI/NCS



Dimensions standard (cm)

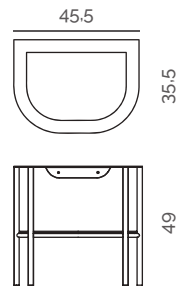

NOTE: vasque Delia non compris avec Meuble Delia.

Fiche technique
du produit



Manuel
d'installation



Meuble Integra



Textures

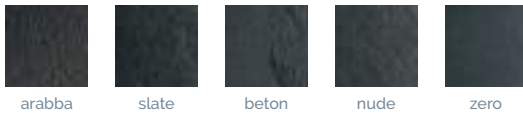

Couleurs

Standard

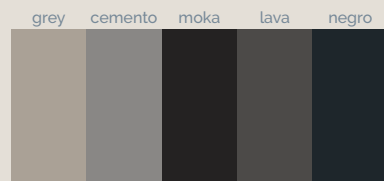
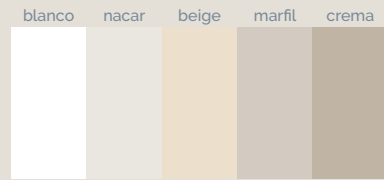

Naturally Made

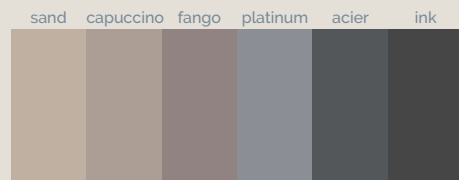

Season

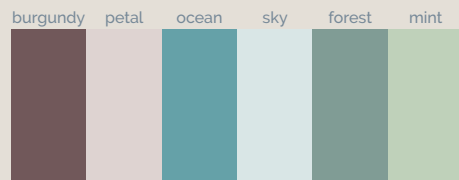

RaI/NCS



Dimensiones estándar (cm)

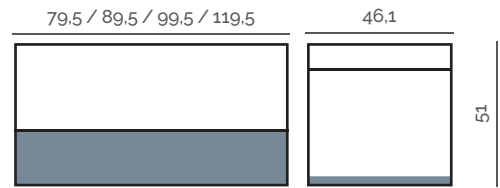

NOTE: plan non compris avec Meuble Integra.

Fiche technique
du produit



Manuel
d'installation



Meuble Integra pose au sol



Meuble Integra pose au sol 120 Slate lava - Plan de toilette Integra SF 120 SX Slate lava - Miroir Urban

Textures

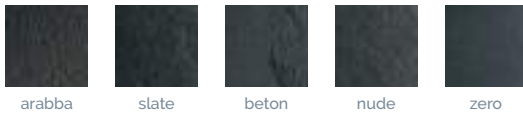

Couleurs

Standard

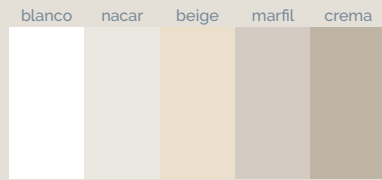

Naturally Made

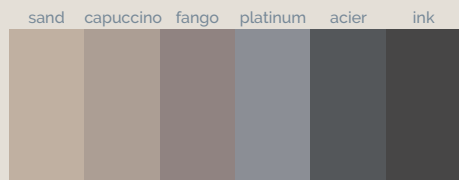

Season

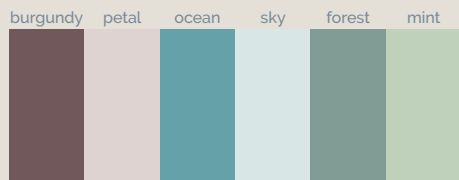

RaI/NCS



Dimensions standard (cm)

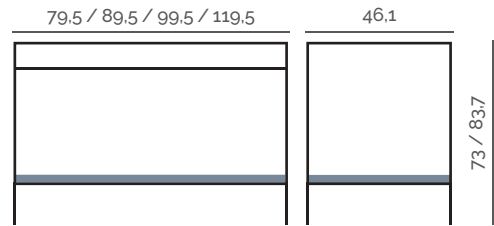

NOTE: plan non compris avec Meuble Integra pose au sol.

Hauteur (cm)

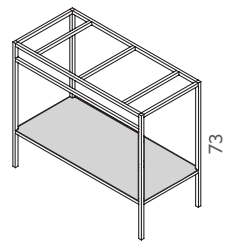

Integra CF

Integra 2 CF

Infinity CF

Infinity 2 CF

One CF

One CFR

One SF

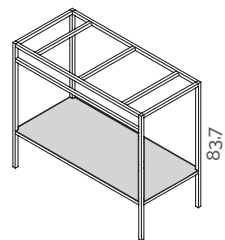

Integra SF

Integra 2 SF

Infinity CFR

Infinity SF

Infinity 2 CFR

Infinity 2 SF

Fiche technique
du produit



Manuel
d'installation



Meuble Urban



Meuble Urban madera 100 cm · Plan de toilette One SF Beton NCS S 3020-G10Y · Vasque On-Top Circle XL Beton crema ·
Panneaux Quiz NCS S 5020-B9oG 240X120 cm · Miroir Urban

Finitions

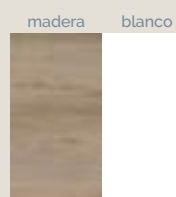

Dimensions standard (cm)

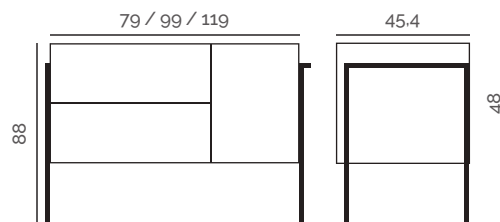

NOTE: plan non compris avec Meuble Urban
NOTE: ce meuble peut être accompagné de n'importe quel plans de toilette du moment que les paramètres suivants sont respectés: long 80, 100 ou 120 cm - large 46 cm - position de la conde centrée.

Fiche technique
du produit



Manuel
d'installation





Textures



Couleurs

Standard



Naturally Made

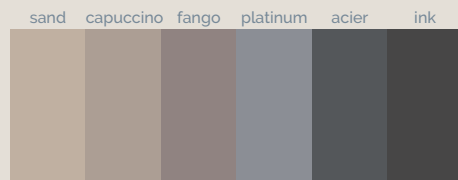

Season

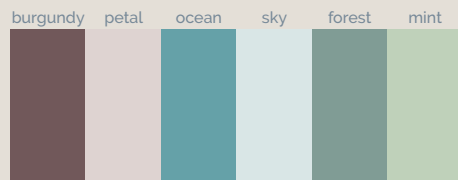

RaL/NCS



Dimensions standard (cm)

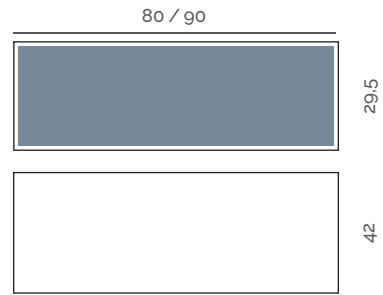

Fiche technique
du produit



Manuel
d'installation



Armoire Show



Armoire Show Quiz NCS S 3050-Y80R

Textures



Couleurs

Standard

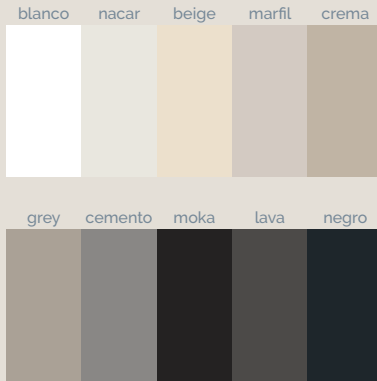

Naturally Made

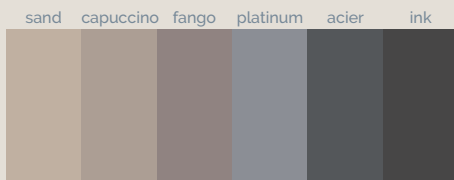

Season

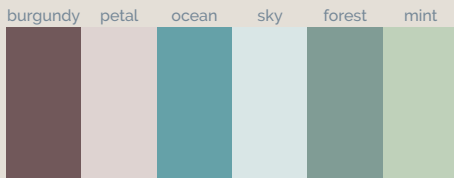

RaI/NCS



Dimensions standard (cm)

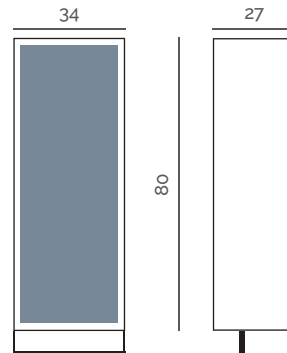

Fiche technique
du produit



Manuel
d'installation



Tabouret Show



Tabouret Show blanco Slate NCS S 5540-R90B · Baignoire Chrea · Panneau Hera Zero NCS S 2050-Y 220x100 cm

Textures

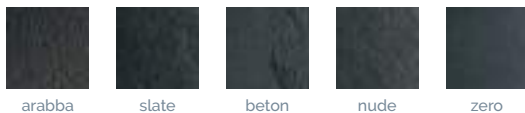

Couleurs

Standard

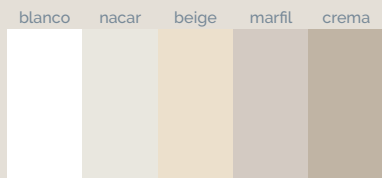

Naturally Made

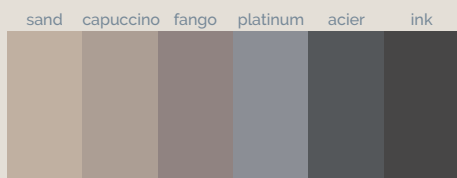

Season

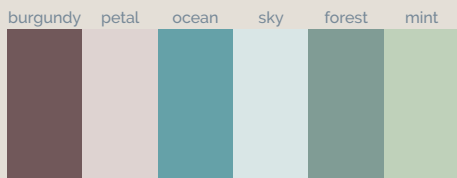

RaI/NCS



Dimensions standard (cm)

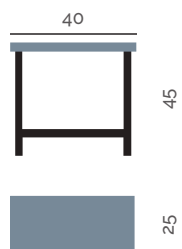

Fiche technique
du produit



Siège mural Show



Textures

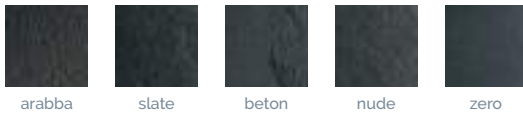

Couleurs

Standard

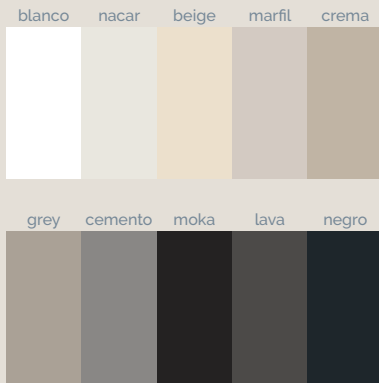

Naturally Made

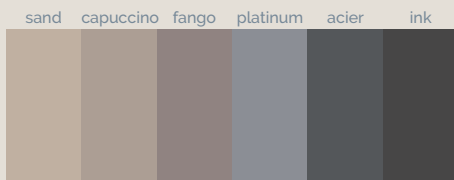

Season

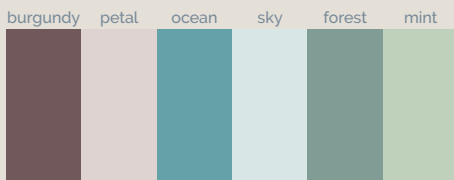

RaI/NCS



Dimensions standard (cm)

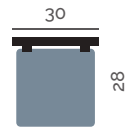

Fiche technique
du produit



Manuel
d'installation



Étagère Box



Textures

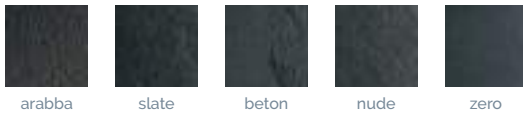

Couleurs

Standard

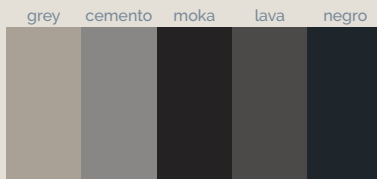
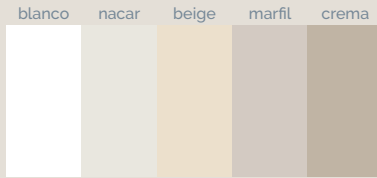

Naturally Made

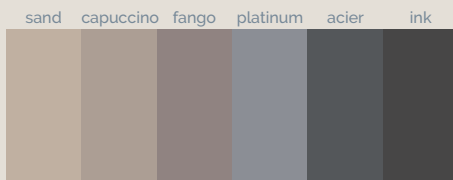

Season

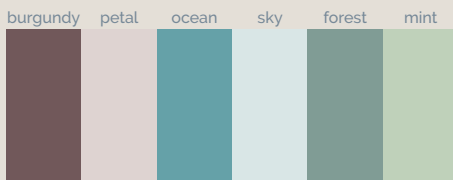

RaI/NCS



Dimensions standard (cm)

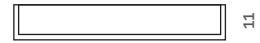
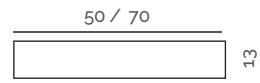

Fiche technique
du produit



Manuel
d'installation



Étagère Show



Étagère Show blanco Beton blanco · Panneau Basic Beton crema 250x100 cm

Textures

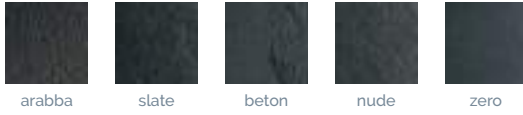

Couleurs

Standard

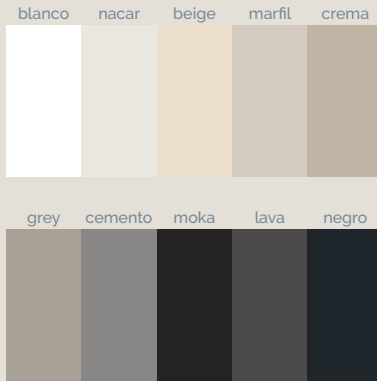

Naturally Made

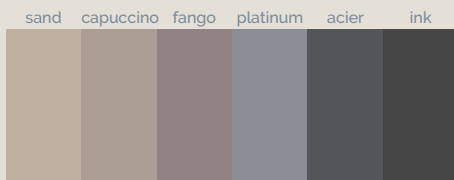

Season

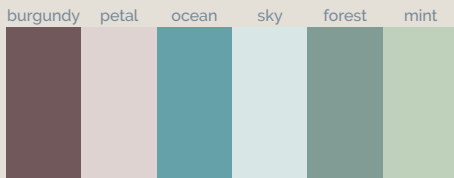

RaI/NCS



Dimensions standard (cm)

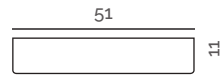

Fiche technique
du produit



Manuel
d'installation



Étagère Corner Show



Étagère Corner Show negro Slate lava · Panneau Basic Slate marfil

Textures

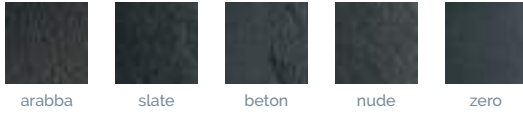

Couleurs

Standard



Naturally Made

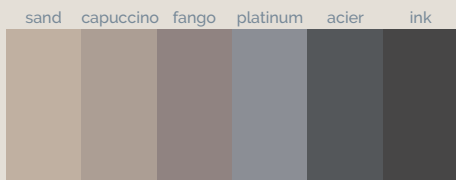

Season

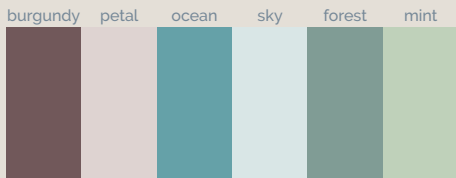

RaI/NCS



Dimensions standard (cm)

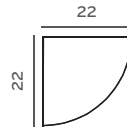

Fiche technique
du produit



Manuel
d'installation



Habillage Bâti



Habillage Bâti Zero negro

Textures

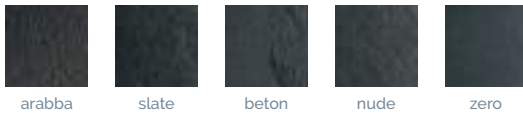

Couleurs

Standard



Naturally Made

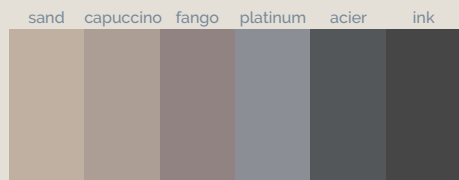

Season

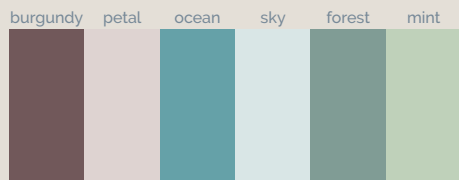

RaI/NCS



Dimensions standard (cm)

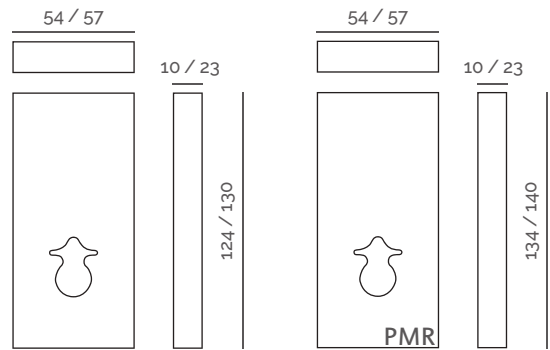

Fiche technique
du produit



Manuel
d'installation



Miroir Moon



Miroir Moon Slate crema · Vasques Chrea · Plan de toilette One CF Slate crema 200x50 cm · Panneaux Basic Slate blanco 250x120 cm

Textures

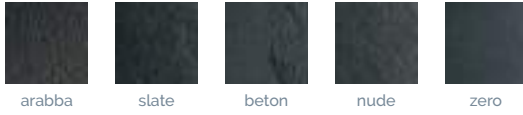

Couleurs

Standard

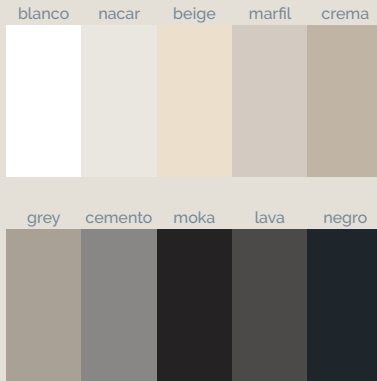

Naturally Made

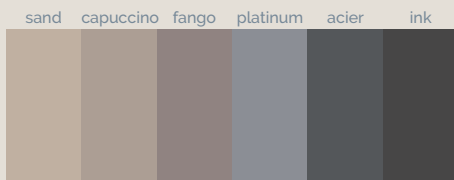

Season

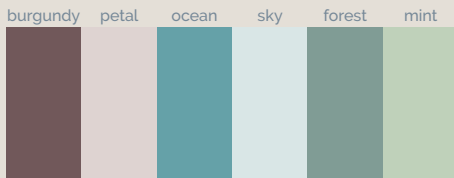

RaI/NCS



Dimensions standard (cm)

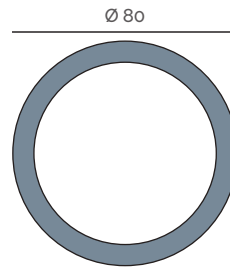

Fiche technique
du produit



Manuel
d'installation



Miroir Urban





Dimensions standard (cm)

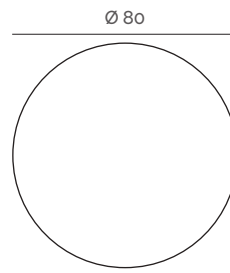

Fiche technique
du produit



Manuel
d'installation



Miroir Show



Miroirs Show Slate cemento · Panneaux Basic Slate crema 250x100 cm · Vasques On-Top Square XL Slate cemento

Textures

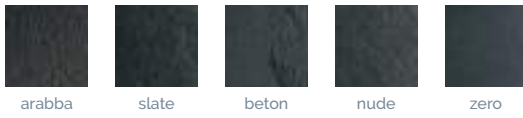

Couleurs

Standard



Naturally Made

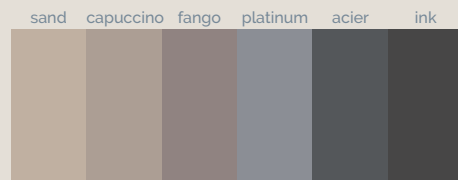

Season

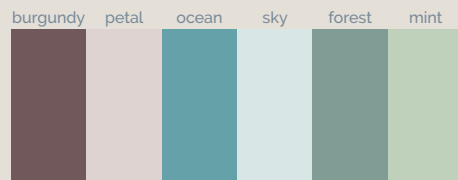

RaI/NCS



Dimensions standard (cm)

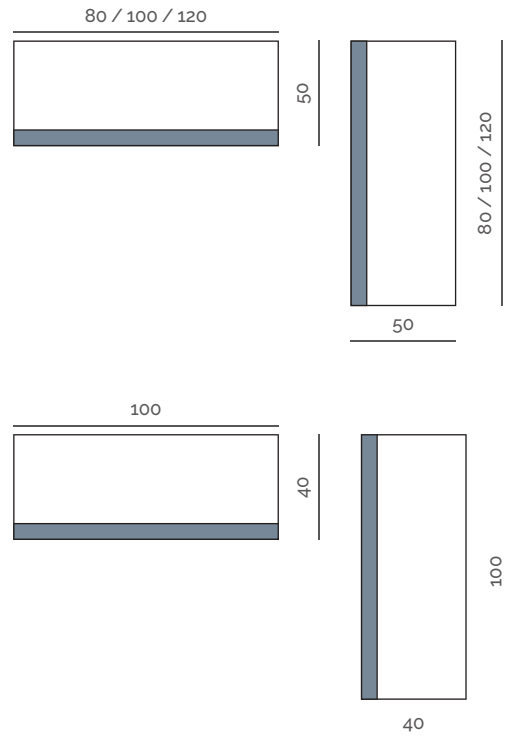

Fiche technique
du produit



Manuel
d'installation



Colonne de douche Kendo



Colonne de douche Kendo Slate NCS S 6010-B30G · Panneaux Basic Slate blanco 240x100 cm · Étagère Show inox Slate NCS S 6010-B30G

Textures

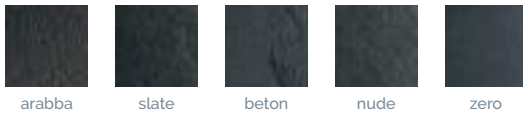

Couleurs

Standard



Naturally Made

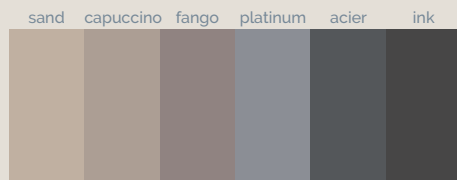

Season

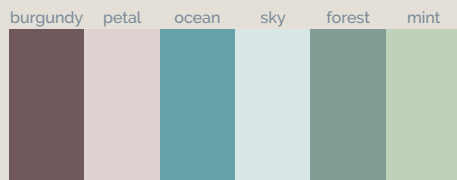

RaL/NCS



Dimensions standard (cm)

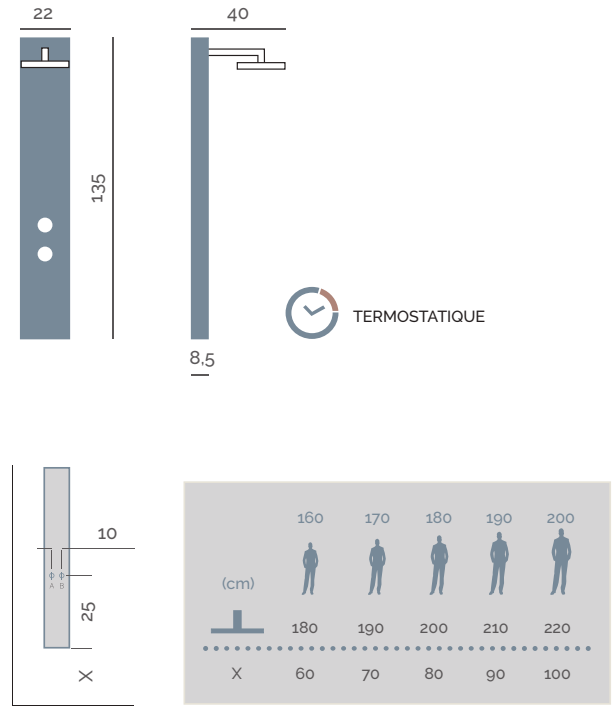

Fiche technique
du produit



Manuel
d'installation







Information technique

<i>Bondes disponibles</i>	326
<i>Bondes click-clack et de livre écoulement disponibles</i>	327
<i>Compléments receveurs de douche</i>	328-329
<i>Compléments baignoires</i>	330-331
<i>Compléments totems</i>	330-331
<i>Compléments plans de toilette</i>	332-333
<i>Compléments vasques</i>	334-335
<i>Certifications Akron</i>	336-337
<i>Certifications Dolotek</i>	338
<i>Usage et entretien</i>	339
<i>Caracteristiques des produits Akron</i>	339-340
<i>Réparation</i>	341-342
<i>Conditions generales de vente</i>	343-344

Bondes disponibles

RECEVEURS DE DOUCHE

Standard

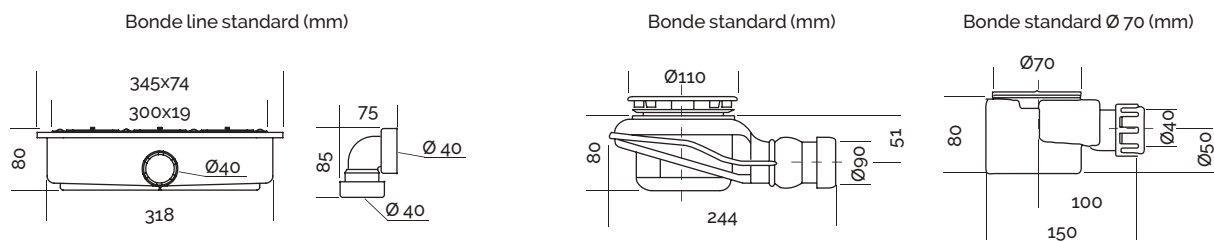

Optionnel

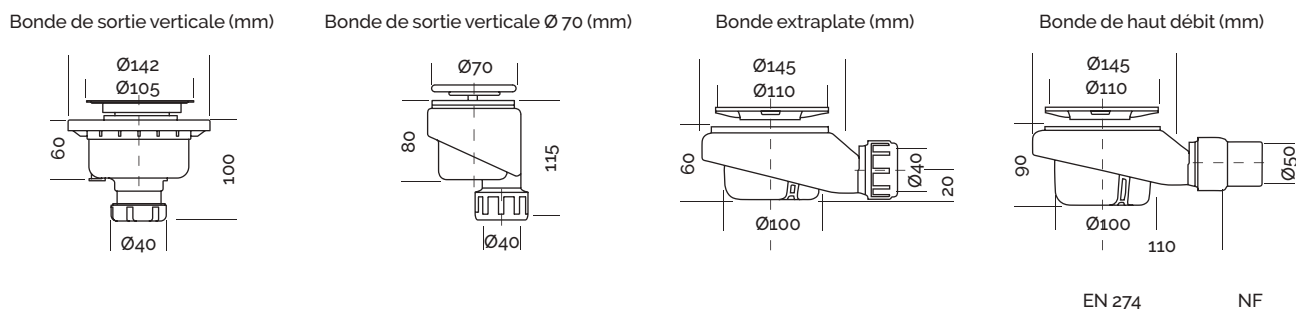

EN 274 NF

Bonde line standard

Bonde standard



Bonde standard Ø70



Bonde de sortie verticale

Bonde de sortie verticale Ø70

Bonde extraplate

Bonde de haut débit



BAIGNOIRES

Standard

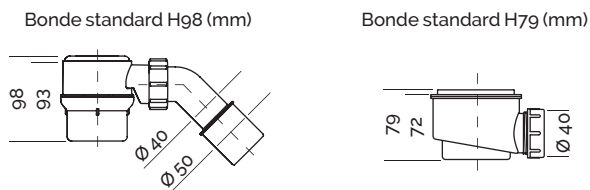

EN 274

NF

Bonde standard H98



Bonde standard H79



Bondes click-clack et de livre écoulement disponibles

BAIGNOIRES

Bonde click-clack Akron (mm)

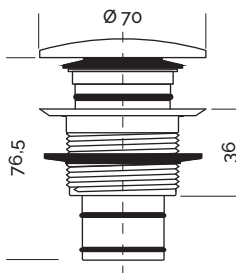

Bonde click-clack chrome (mm)

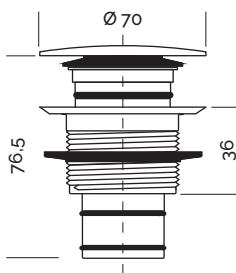

Bonde click-clack Dolotek (mm)

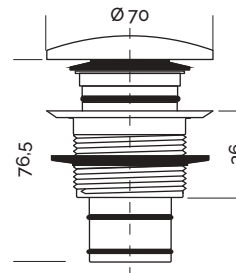

PLANS DE TOILETTE, VASQUES ET TOTEMS

Bonde click-clack Akron (mm)

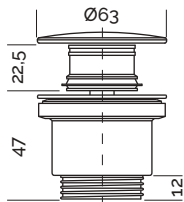

Bonde à écoulement livre Akron (mm)

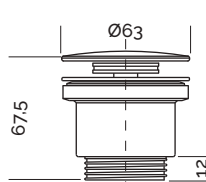

Bonde click-clack chrome (mm)

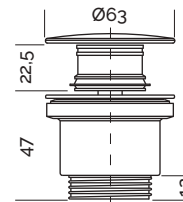

Bonde à écoulement livre chrome (mm)

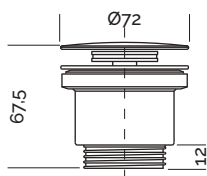

Bonde Pop Down chrome (mm)

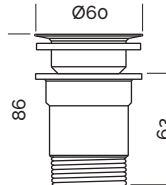

Bonde plate chrome (mm)

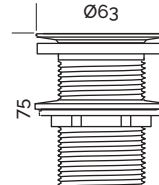

Bonde click-clack avec trop-plein chrome (mm)

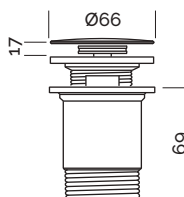

RECEVEURS DE DOUCHE COMPLÉMENTS

	Standard	Nat. Made	Season	Ral/NCS	Base Slate	Base Beton	Base Zero	Base Nude
Bonde line standard								
					✓	✓	✓	✓
Bonde standard								
Bonde standard Ø70								
					✓	✓	✓	✓
Bonde de sortie verticale								
Bonde de sortie verticale Ø70								
					🛒	🛒	🛒	🛒
Bonde extraplate								
					🛒	🛒	🛒	🛒
Bonde de haut débit								
	📦	📦	📦	📦	🛒	🛒	🛒	🛒
Rebord (5x4,1 cm)								
	📦	📦	📦	📦	🛒			
Zone de séchage								
	📦	📦	📦	📦	🛒	🛒	🛒	🛒
Habillage								
					✓	✓	✓	✓
Grille inox Base / Arq								
	📦	📦	📦	📦	✓	✓	✓	✓
Grille Akron Base / Arq (Mia, Geo, Lux)								
	📦	📦	📦	📦				
Grille Akron Unic Slate (Deco, Dune, Drop)								
	📦	📦	📦	📦				
Cache bonde Akron Halo Slate								
	📦	📦	📦	📦				
Cache bonde Akron Areia Slate Evo								
	📦	📦	📦	📦				
Grille Akron Natur Wave								
	📦	📦	📦	📦				
Grille Akron Smart Quiz								
	📦	📦	📦	📦				
Cache bonde Akron Tempo Arabba								
	📦	📦	📦	📦				
Cache bonde Akron Flow Zero								
	📦	📦	📦	📦				
Grille Akron Focus Beton								
Anneau de finition Focus Beton								
Grille inox Prisma Slate								

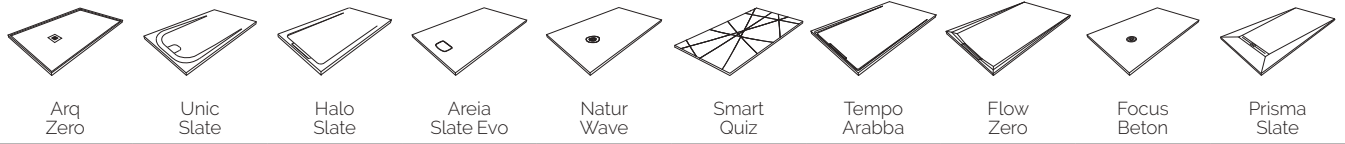

Arq Zero	Unic Slate	Halo Slate	Areia Slate Evo	Natur Wave	Smart Quiz	Tempo Arabba	Flow Zero	Focus Beton	Prisma Slate
		✓				✓	✓		
✓	✓		✓	✓	✓			✓	
									✓
✓	✓		✓	✓	✓			✓	
									✓
🛒	🛒		🛒	🛒	🛒			🛒	
🛒	🛒		🛒	🛒	🛒			🛒	
								🛒	🛒
	🛒	🛒	🛒						🛒
🛒	🛒	🛒				🛒	🛒	🛒	🛒
✓									
✓									
	✓								
		✓							
			✓						
				✓					
					✓				
						✓			
							✓		
								✓	
								✓	
									✓

BAIGNOIRES COMPLÉMENTS

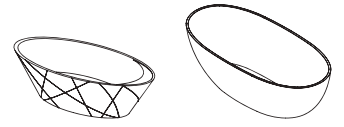

		Standard	Nat. Made	Season	RaL/NCS	Blanco mate	Opal Quiz	Lech
	Akron	☒	☒	☒	☒		☑	
	Dolotek					☒		☑
	Bonde click-clack Akron	☒	☒	☒	☒		☑	
	Bonde click-clack blanc					☒		☑
	Bonde click-clack chrome							☒
	Bonde click-clack Dolotek					☒		
	Bonde standard H98						☑	☑
	Bonde standard H79							
	Trop-plein intégré						☑	
	Trop-plein chromé							
	Pieds réglables							

TOTEMS COMPLÉMENTS



		Standard	Nat. Made	Season	RaL/NCS	Blanco mate	Icon	Levi
	Akron	☒	☒	☒	☒		☑	
	Dolotek					☒		☑
	Bonde click-clack Akron chrome / noir	☒	☒	☒	☒		☒	
	Bonde à écoulement livre Akron chrome / noir	☒	☒	☒	☒		☒	
	Bonde click-clack chrome avec trop-plein							☒
	Bonde Pop Down chrome							
	Bonde plate chrome							
	Cache bonde Dolotek					☒		
	Système de fixation						☑	☑
	Trop-plein							☑



Nevis

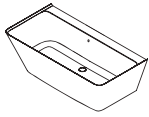

Dewa



Voss



Chrea

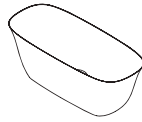

Levi

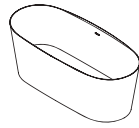

Vars



Venet

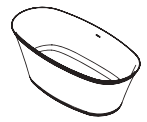

Boreal

✓	✓	✓	✓	✓	✓	✓	✓
				✓			
				🛒			
✓	✓	✓	✓		✓	✓	✓
	✓	✓	✓	✓	✓	✓	✓
✓							
			✓		✓	✓	✓
	✓	✓					
✓	✓			✓	✓		✓

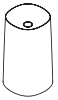

Vars

✓
🛒
🛒
✓

PLANS DE TOILETTE COMPLÉMENTS

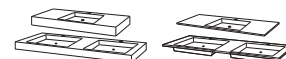

		Standard	Nat. Made	Season	Ral/NCS	Blanco mate	Integra CF Integra 2 CF	Integra SF Integra 2 SF
	Akron	☒	☒	☒	☒		☑	☑
	Dolotek					☒		
	Vasque 42 (30 x 42 cm)	☒	☒	☒	☒			
	Vasque 52 (30 x 52 cm)	☒	☒	☒	☒			
	Vasque 52 Round (30 x 52 cm)	☒	☒	☒	☒			
	Vasque 62 (30 x 62 cm)	☒	☒	☒	☒			
	Vasque 50 (26,7 x 50 cm)	☒	☒	☒	☒		☑	☑
	Vasque 104 (26,7 x 104 cm)	☒	☒	☒	☒			
	Vasque 38 (23,4 x 38 cm)	☒	☒	☒	☒			
	Vasque 55 (31,5 x 55,1 cm)					☒		
	Socle	☒	☒	☒	☒		☑	☑
	Système de fixation						☑	
	Porte-serviettes / Système de fixation							
	Porte-serviettes Show frontale (40 x 4 cm)						🛒	
	Porte-serviettes Show droit (40 x 4 cm)							
	Porte-serviettes Show gauche (40 x 4 cm)							
	Porte-serviettes Moiwa (50 x 5 cm)							
	Bonde click-clack Akron chrome / noir	☒	☒	☒	☒		🛒	🛒
	Bonde à écoulement livre Akron chrome / noir	☒	☒	☒	☒		🛒	🛒
	Bonde click-clack chrome							
	Bonde à écoulement livre chrome							
	Bonde Pop Down chrome							
	Bonde plate chrome							



Integra CF
120XL

Integra SF
120XL

Infinity CF
Infinity 2 CF

Infinity CFR
Infinity 2 CFR

Infinity SF
Infinity 2 SF

One CF

One CFR

One SF

Mini

Moiwa

✓	✓	✓	✓	✓	✓	✓	✓	✓	
									✓
		✓	✓	✓					
		✓	✓	✓					
		✓	✓	✓					
		✓	✓	✓					
✓	✓								
								✓	
									✓
✓	✓	✓	✓	✓	✓	✓	✓		
✓		✓	✓		✓	✓		✓	✓
								✓	
🛒		🛒			🛒				
		🛒			🛒				
		🛒			🛒				
									✓
🛒	🛒	🛒	🛒	🛒				🛒	
🛒	🛒	🛒	🛒	🛒				🛒	
									🛒
									🛒
									🛒
									🛒

VASQUES COMPLÉMENTS

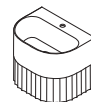

		Standard	Nat. Made	Season	RaI/NCS	Blanco mate	Delia	On-Top Circle
	Akron	☒	☒	☒	☒		✓	✓
	Dolotek					☒		
	Bonde click-clack Akron chrome / noir	☒	☒	☒	☒		🛒	🛒
	Bonde à écoulement livre Akron chrome / noir	☒	☒	☒	☒		🛒	🛒
	Bonde click-clack chrome							
	Bonde à écoulement livre chrome							
	Bonde click-clack Dolotek chrome					☒		
	Bonde Pop Down chrome							
	Bonde plate chrome							
	Cache bonde Dolotek					☒		



		Standard	Nat. Made	Season	RaI/NCS	Blanco mate	Levi Circle XL	Levi Rectangle
	Akron	☒	☒	☒	☒			
	Dolotek					☒	✓	✓
	Bonde click-clack Akron chrome / noir	☒	☒	☒	☒			
	Bonde à écoulement livre Akron chrome / noir	☒	☒	☒	☒			
	Bonde click-clack chrome						🛒	🛒
	Bonde à écoulement livre chrome						🛒	🛒
	Bonde click-clack Dolotek chrome					☒		
	Bonde Pop Down chrome						🛒	🛒
	Bonde plate chrome						🛒	🛒
	Cache bonde Dolotek					☒		



On-Top Circle XL



On-Top Square



On-Top Square XL



On-Top Oval



On-Top Oval XL



On-Top Rectangle



On-Top Rectangle XL



Chrea

✓	✓	✓	✓	✓	✓	✓	
							✓
🛒	🛒	🛒	🛒	🛒	🛒	🛒	
🛒	🛒	🛒	🛒	🛒	🛒	🛒	
							✓



Levi Rectangle XL



Vars Circle



Vars Circle XL



Vars Square XL



Vars Rectangle XL



Venet Circle



Venet Circle XL



Venet Square



Venet Rectangle

✓	✓	✓	✓	✓	✓	✓	✓	✓
🛒					🛒	🛒	🛒	🛒
🛒					🛒	🛒	🛒	🛒
🛒	🛒	🛒	🛒	🛒	🛒	🛒	🛒	🛒
🛒	🛒	🛒	🛒	🛒	🛒	🛒	🛒	🛒
	✓	✓	✓	✓				



Inclus



Optionnel



Disponible

Certifications Akron

CERTIFICAT DE SYSTÈME DE GESTION

Système de gestion de	Activités	Résultat	Norme
Construplas, S.L.U.	Conception, fabrication et vente de receveurs de douche et d'accessoires de salle de bains	✓	ISO 9001:2015
	Conception, fabrication et vente de receveurs de douche	✓	ISO 14001:2015
	Conception, fabrication et vente de receveurs de douche. Conception et vente d'accessoires de salle de bains	✓	ISO 45001:2018

ÉVALUATION DE LA CONFORMITÉ DES RECEVEURS DE DOUCHE À USAGE DOMESTIQUE *

Produit	Essai	Résultat	Norme
Receveur de douche	Aptitude pour le nettoyage	✓	UNE EN 14527:2016 + A1:2019
	Stabilité du fond	✓	
	Résistance chimique	✓	
	Résistance aux variations de la température	✓	

* Aux fins de la norme UNE-EN 14527:2016 + A1:2019, le terme « usage domestique » inclut l'utilisation dans les hôtels, les résidences d'étudiants, les hôpitaux et les bâtiments similaires.

DÉTERMINATION DES PROPRIÉTÉS ANTIDÉRAPANTES

Produit	Essai	Réalisé	Norme
Receveur de douche	Angle critique de glissement. Zones humides pour marcher pieds nus	✓	UNE EN 16165:2022 Annexe A

EXIGENCES FONCTIONNELLES POUR LES RACCORDS SANITAIRES

Produit	Essai	Résultat	Norme
Plan de toilette	Résistance à la charge	✓	UNE EN 14688:2016 + A1:2019
	Évacuation de l'eau	✓	
	Résistance aux variations de la température	✓	
	Résistance aux produits chimiques et aux colorants	✓	
	Aptitude pour le nettoyage	✓	

ÉVALUATION DE LA CONFORMITÉ DES BAIGNOIRES À USAGE DOMESTIQUE

Produit	Essai	Résultat	Norme
Baignoire	Aptitude pour le nettoyage	✓	UNE EN 14516:2017 + A1:2019
	Stabilité du fond de la baignoire	✓	
	Résistance aux produits chimiques et aux colorants	✓	

ESSAIS CHIMIQUES DE PRODUITS

Type	Réactif	Résultat	Norme
Acides	Acide acétique (CH ₃ COOH) 10% v/v	✓	UNE EN 14527:2016 + A1:2019
Alcalis	Hydroxyde de sodium (NaOH) 5% v/v	✓	
Alcools	Éthanol (C ₂ H ₅ OH) 70% v/v	✓	
Javellisants	Hypochlorite de sodium (NaOCl) 5% de chlore actif (Cl ₂)*	✓	
Agents colorants	Bleu de méthylène 1% m/m	✓	

* Le décolorant spécifié ci-dessus peut être remplacé par du percarbonate de sodium (2Na₂CO₃ - 3H₂O₂) préparé comme suit : Dissoudre 1 g d'un décolorant en poudre à base de percarbonate de sodium disponible dans le commerce et contenant 15% à 30 % du composant actif dans 100 ml d'eau désionisée à température ambiante.

Certifications Dolotek

DÉCLARATION DE PERFORMANCE - RÈGLEMENT (UE) N° 305/2011 ANNEXE III *

Produit	Caractéristique principale	Résultat	Norme
Vasque / Totem / Plan de toilette	Nettoyage	✓	EN 14688:2006 DoP: 400/04/13
	Résistance à la charge		
	Évacuation d'eau		
	Durabilité		
Produit	Caractéristique principale	Résultat	Norme
Baignoire	Nettoyage	✓	EN 14527:2006+A1:2010 DoP 402/02/13
	Durabilité		

* Les essais ont été réalisés à l'Institut des techniques du bâtiment, qui est un membre de l'Organisation européenne pour l'évaluation technique (EOTA, ang. European Organisation of Technical Assessment).

RÉSISTANCE AU FEU *

Propriété	Classification	Critères de classification	Méthode d'essai	Norme
Classification européenne de réaction au feu	E	$F_s \leq 150\text{mm}$ en 20 s	EN ISO 11925-2L 15 s de exposition	EN 13501-1:2007 A1:2009

* Les essais ont été réalisés à l'Institut des techniques du bâtiment, qui est un membre de l'Organisation européenne pour l'évaluation technique (EOTA, ang. European Organisation of Technical Assessment).

RÉSISTANCE AUX CHANGEMENTS DE TEMPÉRATURE *

Produit	Conformité du document	Résultat	Norme
Vasque / Totem / Plan de toilette	LZE03-01224/17/R31NZE	✓	Norme européenne EN 14688
Baignoire	LZE03-01224/17/R31NZE	✓	Norme européenne EN 14516

* Les essais ont été réalisés à l'Institut des techniques du bâtiment, qui est un membre de l'Organisation européenne pour l'évaluation technique (EOTA, ang. European Organisation of Technical Assessment).

RÉSISTANCE AUX PRODUITS CHIMIQUES ET AGENTS COLORANTS *

Type	Réactif	Méthode d'élimination	Effet	Résultat	Norme
Acides	Acide acétique (CH ₃ COOH) 10% v/v	Eau déionisée	Aucune décoloration (tâche), ni aucune détérioration de la surface utilisable n'ont été constatées	✓	EN 14688:2066
Alcalis	Hydroxyde de sodium (NaOH) 5% v/v			✓	
Alcools	Éthanol (C ₂ H ₅ OH) 70% v/v			✓	
Javellisants	Hypochlorite de sodium (NaOCl) 5% de chlore actif (Cl ₂)			✓	
Agents décolorants	Bleu de méthylène 1% m/m			✓	
Sels	Chlorure de sodium (NaCl) 170 g/l, dilué dans 50% d'eau			✓	

* Cest essai a été effectué conformément à la description donnée au point 5.5 de la norme européenne EN 14688:2006, en utilisant tous les produits chimiques figurant au Tableau 2 de ce document.

Usage et entretien

AKRON

Pour profiter pleinement et à long terme de votre receveur merci de suivre les conseils suivants:

Pour le nettoyage quotidien il suffit de rincer avec un tissu microfibrés (non abrasif) le receveur avec de l'eau. NE JAMAIS UTILISER CHIFFONS RAPEAUX (SCOTCH BRITE, NI DE FIBRES NATURELLES), ni de DISSOLVANTS, ACIDES, ALCALIS OU ABRASIFS. Après usage de n'importe quel produit de nettoyage il est nécessaire de rincer abondamment avec de l'eau et savon neutre le receveur afin d'éliminer les possibles restes de produits de nettoyages et assurer une ventilation suffisante de la salle de bain. Pour le nettoyage quotidien nous recommandons d'utiliser Filacleaner de la maison Fila et pour un nettoyage périodique Lithofin KF Nettoyant Sanitaire. Vous pouvez également utiliser un savon neutre non gras.

Eviter tout contact avec laques, dissolvants pour ongles, dissolvants organiques, alcools, acides, alcalis etc...

Si vous utilisez des colorations de cheveux, rincer le receveur de douche avec de l'eau et savon une fois finie la douche.

Pour éliminer les possibles restes de calcaire qui peuvent rester sur le receveur, nous pouvons utiliser un anti calcaire domestique (VIKAL) le diluant avec de l'eau (1L de Viakal pour 3L d'eau) de la manière suivante :

- Enlever la grille Inox su siphon et l'appliquer avec un tissu humide sur toute la surface.

- Laisser agir 15 minutes puis rincer abondamment avec l'eau.

- Remettre la grille et rincer à nouveau le receveur avec de l'eau

Non recommandé pour utilisation en extérieurs

DOLOTEK

Afin de préserver le produit pendant de nombreuses années, merci de suivre les conseils suivants:

1. Pour le nettoyage quotidien, nous recommandons des produits de nettoyage universels sans propriétés abrasives.

2. Après chaque utilisation, rincer la surface intérieure à l'eau et séchez avec un chiffon en coton. Ne pas utiliser de chiffons synthétiques ou en microfibrés, car ils peuvent rayer la surface.

3. Pour éliminer le calcaire, utiliser du vinaigre dilué dans de l'eau.

4. Éliminer les taches tenaces avec de l'eau tiède et des détergents doux ou de l'eau savonneuse. Dans certains cas spécifiques (comme la teinture pour les cheveux ou le vernis à ongles), utiliser du dissolvant ou de l'acétone. Enfin, rincer abondamment à l'eau.

ATTENTION: Seulement en cas de rayures superficielles ou de taches persistantes, il est recommandé d'utiliser une éponge à récurer (Scotch Brite ou similaire) ou une éponge abrasive. Ne pas l'utiliser sur le logo.

Caracteristiques des produits Akron

CONDITIONS DE LIVRASION

Tous les receveurs Akron sont emballés individuellement aux dimensions du receveur. Ils sont livrés avec: 1/ La notice de pose traduite en plusieurs langues. 2/ Une grille en acier inoxydable AISI-304 polie et découpée au laser avec le dessin exclusif d'Acquabella, pour correct au dessus du siphon. 3/ Une bonde de haut débit fabriquée aux normes européennes.

Les réclamations pour dommages ne sont pas acceptées une fois le POD signé.

MODE D'UTILISATION ET D'ENTRETIEN

En suivant ces conseils, vous pourrez prolonger la durée de vie de votre receveur Acquabella pendant de longues années. Pour l'entretien habituel, il faut utiliser un chiffon doux, de l'eau et du savon neutre (il faut éviter les chiffons très râpeux) en vous assurant de la bonne ventilation de votre salle de bain. Dans tous les cas, IL FAUT EVITER L'UTILISATION DE PRODUITS AGRESSIFS, COMME LES DISSOLVANTS OU ENCORE LES ACIDES.

Pendant l'installation, il est très important de recouvrir la surface avec un carton de protection livré avec l'emballage original. Il protégera le receveur des résidus de ciment, colle, silicone, etc.

Si malgré tous ces conseils, à la fin du chantier, votre receveur reste sale avec des produits de pose, vous devez utiliser DETERDEK de FILA.

COMMANDE DE RECEVEURS SUR MESURE

Les receveurs Akron, sauf ceux de la série Arq et Flow, peuvent être livrés coupés sur mesure.

Nous ne pouvons pas faire de coupes arrondies ou autres formes spéciales, les coupes étant toujours droites.

Pour les découpes sur mesure, il n'y a pas de plus-values et il faut calculer votre prix en fonction du receveur standard dont on se sert au départ.

Pour confirmer votre commande, il faut suivre les conseils suivants: 1/ Préciser la longueur finale du receveur. 2/ Préciser la largeur finale du receveur. 3/ Si nécessaire, dessiner un croquis avec les dimensions et formes du receveur.

À la demande du client, nous pouvons repeindre les parties coupées avec la même couleur que le receveur mais nous attirons l'attention sur le fait qu'elles n'auront pas logiquement la même texture.

INSTALLATION DES PANEAUX MURAUX ET SOCLES POUR REMONTEES

Nous complétons notre collection avec des panneaux muraux et socles de surélévation sur mesure.

Les éléments Akron peuvent se couper en utilisant des disques à céramique. Le collage doit se faire en suivant la notice de pose qui accompagne le produit à la livraison.

MODE DE RÉPARATION D'UN RECEVEUR AKRON

Il est possible de retrouver la couleur d'origine dans le cas d'une mauvaise installation ou d'utilisation du receveur. Vous pouvez commander le Kit de Réparation en nous précisant la couleur du receveur.

Avant son application, il faut dégraisser la zone à repeindre avec de l'alcool à nettoyer. Après, utiliser un petit rouleau de laque et attendre au minimum 48/72 heures pour son séchage avant de le réutiliser.

QUESTIONS HABITUELLES

- Quel outil il faut utiliser pour couper les receveurs et panneaux sur mesure?
Il faut utiliser une machine à disque diamant.

- Quels produits doit on utiliser pour le nettoyage et entretien des receveurs?
Pour nettoyer les possibles restes de ciment colle et mortier nous utiliserons un désincrustant pour joints appelé NETTOYANT SANITAIRE de chez LITHOFIN, ou similaire, car il est spécifique pour l'élimination des restes de chantier, il s'utilise aussi pour l'élimination des autres composants comme le salpêtre, oxyde et calcaire, lire les notices d'usage. NE PAS FROTTER laisser agir le produit. NE JAMAIS UTILISER D'ÉPONGES RAPPENSES (SCOTCH BRITE, ni de FIBRES NATURELLES), ni DISSOLVANTS, ACIDES, ALCALIS OU ABRASIFS. Après avoir nettoyer, rincer avec de l'eau abondante et assurer une ventilation suffisante de la salle de bain. Non dangereux pour l'usager ni pour l'environnement.

- Au premier usage du receveur, l'eau s'évacue très doucement malgré son installation correcte.

Pendant la fabrication et son transport, les receveurs prennent de l'électricité statique. Si vous le nettoyez avec de l'eau et savon la première fois avant de l'utiliser, cet effet diminuera considérablement. Au fil temps cet effet disparaîtra complètement.

- Quels sont les caractéristiques et dimensions du siphon?
La bonde dispose d'un siphon incorporé que vous pouvez retirer facilement en enlevant la grille inox pour son correct nettoyage et entretien ou, dans le cas où vous auriez un deuxième siphon dans la salle de bain, le supprimer définitivement.

- Quel produit il faut utiliser pour coller les panneaux et les receveurs?
Le collage des différents éléments doit se faire en utilisant SIKAFLEX o SIKABOND T2 (Sika), SUPERFLEX (Kerakoll) et le scellage avec matériel de jointoyer céramique ou silicone non acide.

- Quelle est l'épaisseur des panneaux pour les murs?
L'épaisseur dans ce cas est de 6 mm. 3D: Min 6mm, Máx:10mm.

- Quelle est la dimension du socle pour remonter les receveurs?
La hauteur des socles est 9 cm.

- Comment faut il commander les pièces détachées?
Vous pouvez commander les pièces détachées au Service commercial.Acquabella.

- Comment peut exposer les receveurs?
Vous avez la possibilité de les exposer dans un présentoir composé de deux receveurs recto-verso.

Réparation

KIT DE RÉPARATION AKRON

Procédure pour la réparation d'un receveur:

PRÉPARER LA ZONE À RÉPARER:

1. Bien nettoyer la zone à peindre, en faisant spécialement attention aux restes gras ou savonneux. Peut s'appliquer pour ce processus de l'alcool à brûler ou acétone diluée dans de l'eau avec un tissu qui ne laisse aucun type de duvet.
2. La surface doit être totalement propre et sèche.
3. Protéger avec un ruban de carrosserie ou similaire, les zones susceptibles de se tacher (carrelages, paroi de doucheetc...)

MODE D'APPLICATION:

4. Ouvrir les récipients.
5. Verser la laque colorée et le catalyseur dans une petite cuvette plastique de peintre et mélanger.
6. Utiliser un rouleau de peinture de laine de 8 ou 10 cm de bonne qualité, en faisant de longs traits et toujours dans le même sens, renouveler si nécessaire.
7. En fonction de l'état à restaurer, il est possible que vous soyez obligés d'appliquer plusieurs couches de peinture. Pour cela laisser sécher au moins 40 minutes avant d'appliquer la seconde couche.
8. Finalement laisser sécher 48 heures avant de retirer le ruban de carrosserie de protection.



Kit de réparation Akron



NOTE: un kit clouvre une surface maximale de 140x100 cm.

MINI KIT DE RÉPARATION AKRON

INSTRUCTIONS POUR LA RÉPARATION SUPERFICIEL D'UN RECEVEUR DE DOUCHE

Il est possible de réparer la couleur d'un receveur AKRON d'Acquabella dans le cas où la surface se serait détériorée par un usage indu. Dans ce cas vous pouvez demander un kit de réparation qui doit être commander en indiquant la couleur du receveur à réparer. CE KIT NE CONTIENT QU'UN FLAÇON. IL N'EST ADAPTÉ QU'À DES RÉPARATIONS SUPERFICIELLES. ATTENTION: IL EST POSSIBLE QUE LA COULEUR DU KIT VARIE LÉGÈREMENT PAR RAPPORT A LA COULEUR ORIGINALE.

Procédure pour la réparation d'un receveur:

1. Bien nettoyer la zone à peindre, en faisant spécialement attention aux restes gras ou savonneux. Peut s'appliquer pour ce processus alcool à brûler ou acétone diluée dans de l'eau avec un tissu qui ne laisse aucun type de duvet.
2. La surface doit être totalement propre et sèche.
3. Ouvrir le flacon.
4. Remuer avec le pinceau.
5. Utiliser le pinceau afin de peindre la surface à réparer.
6. Laisser sécher 48 heures.



Mini kit de réparation Akron



KIT DE RÉPARATION DE RESINE

INSTRUCTIONS POUR LA RÉPARATION EN SURFACE D'UN RECEVEUR DE DOUCHE AKRON ACQUABELLA

Il est possible de réparer votre receveur de douche AKRON Acquabella dans le cas où la surface se serait détériorée par un usage indu. Dans ce cas, vous pouvez solliciter un kit de réparation de résine. Le kit comprend deux récipients, A et B. Procédure de réparation du receveur AKRON:

PRÉPARATION DE LA ZONE À RÉPARER:

1. Nettoyer la zone à réparer en faisant spécialement attention aux restes gras et savonneux. Pour ce faire, appliquer de l'alcool à brûler avec un chiffon microfibre.
2. La surface doit être totalement propre et sèche.
3. Protéger les zones susceptibles de se tâcher (carrelage, paroi de douche, etc...) avec du ruban de masquage.

MODE D'APPLICATION DU KIT DE RÉSINE:

4. Ouvrir les récipients.
5. Mélanger les composants des récipients A et B sur un couteau à enduire.
6. Reboucher l'impact avec la résine.
7. Laisser sécher au minimum 30 minutes. Une fois la résine sèche, retirer le ruban de masquage.
8. Simuler la texture du receveur à l'aide d'une feuille de papier ponce. Enlever le reste de poussière et bien nettoyer la zone.
9. Peindre le receveur à l'aide du kit de réparation de peinture. (A partir de ce point, continuer en suivant les instructions d'application du kit de peinture).



Kit de réparation de resine



KIT DE RÉPARATION DOLOTEK

Ce kit sert à réparer les dommages et les rayures. Il est recommandé de le faire appliquer par un professionnel. Le kit contient tous les éléments nécessaires pour effectuer la réparation et garantir une qualité et une finition professionnelles.

Préparation de la zone à réparer :

1. Retirer les résidus de la surface endommagée à l'aide d'un cutter ou d'un outil tranchant. Appliquer de l'alcool à brûler pour éliminer la poussière à l'aide d'un chiffon en coton qui ne laisse pas de peluches.
2. La surface doit être complètement propre et sèche.
3. Protéger le périmètre de la partie endommagée avec de l'adhésif de masquage.

Mode d'application :

1. Se protéger les mains avec des gants et porter un masque.
2. Verser le pot B (pipette) dans le pot A et remuer à l'aide de la spatule pendant environ 30 secondes jusqu'à obtenir un mélange homogène.
3. Appliquer immédiatement la pâte sur la surface endommagée à l'aide de la spatule. Le matériel doit être appliqué avec excès, en laissant du relief. Laisser sécher pendant au moins 6 heures.
4. Retirer l'adhésif et humidifier le papier de verre avant de l'utiliser. Utiliser d'abord le papier de verre rouge avec le bloc blanc comme support et poncer avec insistance la surface endommagée en faisant de petits cercles. Répéter ensuite le même processus avec le papier de verre gris.
5. Pour une meilleure finition, passer légèrement une éponge à récurer (Scotch Brite ou similaire) sur toute la surface.

*Le kit de réparation a une date d'expiration de 3 mois à compter de la date figurant sur l'emballage.

ATTENTION: Il peut y avoir de légères variations de teintes par rapport à la couleur d'origine. Les kits de réparation doivent être conservés dans un endroit frais et sec, hors de portée des enfants.



Kit de réparation Dolotek



Conditions générales de vente

Les relations commerciales entre Construplas S.L.U. et ses clients sont établies par des CGV qui seront acceptées par l'acheteur lors du passage de la commande. Toutes les commandes réalisées par nos agents commerciaux seront acceptées sur confirmation écrite via fax ou mail.

PRIX
Nos prix publics peuvent varier après notification à l'acheteur. Les nouveaux prix s'appliqueront à toutes les commandes passées à partir de la date de modification. La taxe, actuellement en vigueur, la T.V.A., et toute autre taxe prévue par la loi seront appliquées sur la facture et les prix nets. => a quitar por los catálogos destinados a la exportación, no?
Si les marchandises sont livrées par nos soins conformément aux conditions d'achat convenues avec le client, le montant d'achat minimum (franco) est de 250 euros nets. En dessous de ce montant, nous facturerons 50 euros de frais d'expédition.

PÉRIODE DE VALIDITÉ
Ce tarif entre en vigueur à partir de septembre 2023 et jusqu'à nouvel ordre, date à laquelle le nouveau tarif annule les précédents et est susceptible d'être modifié sans préavis par Construplas S.L.U.

CATALOGUES, OFFRES ET COMMANDES
Les CGV de nos catalogues sont indiquées à titre d'information. Toute commande est considérée conforme dès réception de celle-ci. Aucune annulation ou modification de commande ne sera acceptée après réception de celle-ci. En passant la commande à Construplas S.L.U., le client accepte les CGV ainsi que les tarifs. Les remises à appliquer sur le prix de vente public du catalogue sont négociées avec chaque client. Toute offre de prix exclusive doit accompagner la commande officielle pour acceptation de celle-ci.

ANNULATIONS ET MODIFICATIONS DES COMMANDES
Aucune annulation ou modification de commande ne sera acceptée 24 heures après l'envoi de l'accusé de réception de celle-ci.

RETOURS DE MARCHANDISES
Autorisation de retour de marchandise uniquement sur accord préalable de l'usine. Dans ce cas, la marchandise devra être retournée dans son emballage d'origine et en bon état. Après réception, la marchandise sera contrôlée par notre service qualité. Une décote de 30% sera appliquée et les frais de transport de retour seront à la charge du client. L'avoir correspondant s'effectuera après la réception et vérification de la marchandise.

COMMANDES SPÉCIALES
Pour toute demande spécifique de produits ou dimensions spéciales hors catalogue, veuillez consulter le service commercial.

CARACTÉRISTIQUES ET DONNÉES TECHNIQUES DU PRODUIT
Toute l'information technique publiée dans ce tarif est à titre purement indicatif. Construplas S.L.U., dans le cadre de l'amélioration de ses produits, se réserve le droit de changer, substituer ses références ou composants sans avis préalable.

DIMENSIONS ET TOLÉRANCES
En raison des matériaux utilisés et du processus de fabrication de tous nos produits Akron, ceux-ci peuvent présenter une tolérance de $\pm 0,5\%$ par rapport aux dimensions réelles commandées. Pour tous nos produits Dolotek, ceux-ci peuvent avoir une tolérance de $\pm 1\%$ par rapport aux dimensions réelles demandées.

DÉLAIS DE LIVRAISON
Les délais de livraison apparaissant dans nos confirmations de commande ne sont communiqués qu'à titre indicatif. Tous retards de livraison ayant lieu pour cause de force majeure ou non inhérents à Construplas S.L.U. ne constitueront pas une cause justifiée d'annulation de la commande en question ni d'aucune réclamation pour dommages et intérêts.

INSTALLATION ET MONTAGE
L'installation devra être réalisée par un professionnel du secteur, et en respectant les normes en vigueur. Si les instructions indiquées dans la notice de pose ne sont pas respectées, Construplas S.L.U. ne pourra en aucun cas être tenu responsable des problèmes liés à une installation, un usage et/ou entretien non conforme.

MODES DE PAIEMENT
A négocier.

IMPAYÉS
En cas de facture impayée, de retour d'un virement bancaire, ou similaire, toute commande en cours sera bloquée en usine jusqu'à la résolution du litige.

LITIGES
La volonté de Construplas S.L.U. est de résoudre à l'amiable les litiges et réclamations qui peuvent survenir avec ses clients. Malgré cela, si aucun accord n'est trouvé entre les deux parties, celles-ci s'engagent à se soumettre à la loi d'arbitrage du 5 Décembre 1988 d'Espagne.

CONDITIONS DE GARANTIE
La garantie commerciale dénommée GC, proposée par Construplas S.L.U., est valable uniquement si l'article a été acquis entre pays de l'Union Européenne. Les ventes effectuées en dehors de l'UE ne sont pas soumises à la GC, sauf accord spécifique avec Construplas S.L.U. Cette GC ne porte pas atteinte aux droits du consommateur vis-à-vis des obligations du vendeur, conformément aux dispositions de la directive 1999/44 et aux lois nationales de transposition respectives.
Construplas S.L.U. garantit ses articles et composants contre tout défaut de conformité, à condition qu'ils aient été correctement installés, conformément à la norme en vigueur et respectant les instructions d'installation, et qu'il y ait eu un usage et entretien correct. Le défaut de conformité doit être notifié à Construplas S.L.U. sous 2 mois après le constat. La durée de validité de la présente GC pour les consommateurs est de 3 ans.
À titre d'exception au paragraphe précédent, la période de garantie pour tous les produits exposés dans les salles d'expositions de nos clients est de 1 an. Afin de bénéficier de cette GC le client devra prouver sa validité, justifiée par la facture d'achat du produit ou l'acte d'acquisition de l'immeuble où se trouve le produit en question.

Cette garantie commerciale n'inclut pas :

- Les dommages provenant du transport (si la logistique n'a pas été gérée par Construplas S.L.U.), de l'installation, de l'utilisation et d'un entretien non-conforme ainsi que de manipulations ou réparations réalisées à titre personnel.
- Les dommages provenant d'un manque de nettoyage de fin de chantier, provoquant de la saleté, des incrustations, de la laitance ou d'autres défauts physiques, chimiques ou électrochimiques.
- Les dommages qui, objectivement, ne sont pas inhérents au fabricant.

N.B. CONCERNANT LA GARANTIE

- À la réception de la marchandise, merci de bien vouloir vérifier dans les 24 heures qui suivent que les produits ne sont pas rayés, cassés ou abimés. Tous nos produits sont soumis à un contrôle de qualité avant d'être expédiés.
 - L'installation devra être réalisée par du personnel qualifié en respectant les instructions d'installation et normes en vigueur.
 - Dans le cas où les conseils ci-dessus ne sont pas respectés, la responsabilité de Construplas S.L.U. ne pourra pas être engagée face à des problèmes liés à une mauvaise installation ou utilisation non-conforme.
- Dans ce cas, les frais tels que le démontage de la paroi, du carrelage, ou d'autres produits, ne seront pas pris en charge par Construplas S.L.U.

Les couleurs, poids et dimensions inclus dans ce catalogues sont orientatifs. La finition du matériel pourra différer légèrement des photos montrées.
CONSTRUPLAS S.L.U., dans le cadre de l'amélioration de ses produits, se réserve le droit de changer, substituer ou altérer ses références ou composants sans avis préalable.
Il reste absolument interdite n'importe quelle reproduction partielle ou totale non autorisée. Cette violation sera poursuivie par la Loi.

CONSTRUPLAS S.L.U. Pol. Ind. Belcaire Calle C Parcela 1201 · CP.12600 Vall d'Uixó (Castellón) España Tel. +34 964 66 19 19 Fax. +34 964 69 60 84 acquabella@construplas.com

